

PREISLISTE

PRICE LIST

Version DE & ENG 02/2021

WICHTIGE HINWEISE IMPORTANT INFORMATION

Fertigungstechnische Toleranzen und Änderungen sind uns vorbehalten. Alle Angaben ohne Gewähr.
Alle dargestellten Preise verstehen sich in Euro zzgl. der gesetzlichen MwSt.

We explicitly reserve the right of production tolerances and changes in our products.
All information subject to change. The prices specified by us are in Euros and subject to VAT.

Gültig ab 15.02.2021 Valid from February 15th 2021

GEBRAUCH DER PREISLISTE

HOW TO USE THE PRICELIST

ZUSAMMENSETZUNG DER BESTELNUMMERN HOW TO DETERMINE YOUR ORDER NUMBER

Artikelnummer / Bestellnummer

Die Bestellnummer setzt sich wie folgt zusammen:

Article number / order number

Order number is a combination of:

Beispiel

Example

„06410 31“

Art.-Nr. (5-stellig)
Art. No. (5-digit)

06410



31

Kennziffer der Oberfläche
Finish code number

STAFFELPREISE SCALED PRICING

STÜCKPREISE BEI ABNAHME VON
PRICE PER PIECE WITH PURCHASE OF

STÜCKPREISE FÜR ARTIKEL
MIT OBERFLÄCHE
PRICE PER PIECE FOR ITEMS
WITH FINISH

Art.-Nr. Art. No.:	06410	06411	06415																																																				
																																																							
	Glastürbeschlag, G-W 90° Nach außen öffnend Für 8 mm ESG Glass door hinge, g-w 90° Opens outwards For 8 mm tempered glass	Glastürbeschlag, G-W 90° Nach innen öffnend Für 8 mm ESG Glass door hinge, g-w 90° Opens inwards For 8 mm tempered glass	Glastürbeschlag, G-W 90° Nach außen öffnend Für 8 mm ESG Glass door hinge, g-w 90° Opens outwards For 8 mm tempered glass																																																				
	<table border="1"> <thead> <tr> <th>€ Stückpreis Price per piece</th> <th>100 Stk. pcs.</th> <th>50 Stk. pcs.</th> <th>20 Stk. pcs.</th> <th>1 Stk. pc.</th> </tr> </thead> <tbody> <tr> <td>31</td> <td>65,45</td> <td>72,00</td> <td>76,00</td> <td>80,00</td> </tr> <tr> <td>46</td> <td>75,27</td> <td>82,80</td> <td>87,40</td> <td>92,00</td> </tr> <tr> <td>55</td> <td>81,82</td> <td>90,00</td> <td>95,00</td> <td>100,00</td> </tr> </tbody> </table>	€ Stückpreis Price per piece	100 Stk. pcs.	50 Stk. pcs.	20 Stk. pcs.	1 Stk. pc.	31	65,45	72,00	76,00	80,00	46	75,27	82,80	87,40	92,00	55	81,82	90,00	95,00	100,00	<table border="1"> <thead> <tr> <th>100 Stk. pcs.</th> <th>50 Stk. pcs.</th> <th>20 Stk. pcs.</th> <th>1 Stk. pc.</th> </tr> </thead> <tbody> <tr> <td>65,45</td> <td>72,00</td> <td>76,00</td> <td>80,00</td> </tr> <tr> <td>75,27</td> <td>82,80</td> <td>87,40</td> <td>92,00</td> </tr> <tr> <td>81,82</td> <td>90,00</td> <td>95,00</td> <td>100,00</td> </tr> </tbody> </table>	100 Stk. pcs.	50 Stk. pcs.	20 Stk. pcs.	1 Stk. pc.	65,45	72,00	76,00	80,00	75,27	82,80	87,40	92,00	81,82	90,00	95,00	100,00	<table border="1"> <thead> <tr> <th>100 Stk. pcs.</th> <th>50 Stk. pcs.</th> <th>20 Stk. pcs.</th> <th>1 Stk. pc.</th> </tr> </thead> <tbody> <tr> <td>66,27</td> <td>72,90</td> <td>76,95</td> <td>81,00</td> </tr> <tr> <td>76,91</td> <td>84,60</td> <td>89,30</td> <td>94,00</td> </tr> <tr> <td>83,05</td> <td>91,35</td> <td>96,43</td> <td>101,50</td> </tr> </tbody> </table>	100 Stk. pcs.	50 Stk. pcs.	20 Stk. pcs.	1 Stk. pc.	66,27	72,90	76,95	81,00	76,91	84,60	89,30	94,00	83,05	91,35	96,43	101,50
€ Stückpreis Price per piece	100 Stk. pcs.	50 Stk. pcs.	20 Stk. pcs.	1 Stk. pc.																																																			
31	65,45	72,00	76,00	80,00																																																			
46	75,27	82,80	87,40	92,00																																																			
55	81,82	90,00	95,00	100,00																																																			
100 Stk. pcs.	50 Stk. pcs.	20 Stk. pcs.	1 Stk. pc.																																																				
65,45	72,00	76,00	80,00																																																				
75,27	82,80	87,40	92,00																																																				
81,82	90,00	95,00	100,00																																																				
100 Stk. pcs.	50 Stk. pcs.	20 Stk. pcs.	1 Stk. pc.																																																				
66,27	72,90	76,95	81,00																																																				
76,91	84,60	89,30	94,00																																																				
83,05	91,35	96,43	101,50																																																				

OBERFLÄCHENBESCHREIBUNGEN AUF SEITE 57
DESCRIPTION OF FINISHES ON PAGE 57

OBERFLÄCHEN FINISHES	Kennziffer für Artikelnummer Article No. endings for finish	SONDEROBERFLÄCHEN SPECIAL FINISHES	Kennziffer für Artikelnummer Article No. endings for finish
ALUMINIUMBASIS: ALUMINUM BASE:		Sonderoberfläche Special Finishes	
Silberfarbig eloxiert Silver color anodized	10	Glanzvernickelt Bright nickel	36
Chromähnlich eloxiert (ähnlich OF 31 bei Galvanik) Chrome color anodizes (like finish 31 with plating)	11	Mattvernickelt Satin nickel	51
Gebüzt, silberfarbig eloxiert (EV1 ähnlich OF 46 bei Galvanik) Stained, silver-colored anodized (like finish 46 with plating)	16	KL* Nickel gebürstet (Edelstahltypik) KL* brushed nickel (stainless steel look)	55
Alinox (Edelstahleffekt, ähnlich OF 55 bei Galvanik) Alinox (stainless steel effect, like finish 55 with plating)	17	Messing Braun Brass brown	59
MESSINGBASIS: BRASS BASE:		Feingold Fine gold	61
Glanzverchromt Bright chrome	31	Gelbgold (Farbton ähnlich wie Messing) Yellow gold (brass color)	62
Mattverchromt Satin chrome	32	Altgold Antique gold	63
Edelstahl Stainless steel	33	Altgold gebürstet mit Klarlack Antique gold brushed with clear lacquer	63

Bitte beachten Sie, dass wir für Ausführung einer Staffelbestellung einen Vorlauf von min. 4 Wochen benötigen.
Please note that we need a min. of 4 weeks to process orders with scaled pricing.



100%

solides Messing
solid brass

MIT TRADITION, HANDWERK & LEIDENSCHAFT

Unsere Beschläge fertigen wir in der Regel aus hochwertigem und solidem Messing, in Sonderheit die für den Sanitärbereich. Messing ist ein sehr langlebiges und vielseitiges Material, mit einigen entscheidenden Vorteilen:

- **Sicherheit.** Messing ist nicht nur stabil, sondern hat gleichzeitig eine gewisse Flexibilität. Schon die alten Seefahrer wussten nicht nur die Druck, sondern auch die Schlagfestigkeit zu schätzen: große Vorteile gegenüber spröderen Metallen.
- **Oberflächen.** Neben den sehr guten Werten bei der Korrosions beständigkeit lässt sich Messing hervorragend polieren und besonders mit galvanischen Oberflächen veredeln, z.B. mit Chrom. Messing wird dementsprechend vielfältig in der Sanitärindustrie als Basismaterial für Armaturen genutzt.
- **Sonderlösungen.** Messing lässt sich mit der richtigen Manufaktur einrichtung gut zerspanen und bearbeiten und bietet gleichzeitig beste Voraussetzungen für verschiedenste Oberflächen.

Nicht nur bei der Auswahl der Materialien setzen wir auf Hochwertigkeit. Bis heute steht Handarbeit als Garant für gute Qualität – und das zu Recht. Unsere Produkte werden fast ausschließlich in unserer Manufaktur in Waldbröl händisch gefertigt. Materialauswahl und Fertigung vor Ort dienen auch der Nachhaltigkeit, ein wesentliches Ziel unseres Unternehmens.

Unser Team, bestehend u.a. aus Ingenieuren, Meistern und Glastechnikern, arbeitet stets daran, unsere Produkte in Funktionalität und Design zu perfektionieren. Auch bei der Fertigung von Sonderlösungen oder der Planung komplexer Projekte sind wir gerne Ihr Ansprechpartner und unterstützen Sie bei Ihrem Bauvorhaben.

WITH TRADITION, PASSION & CRAFTSMANSHIP

We usually manufacture our fittings from high-quality and solid brass, at least those for use in the sanitary area.

Brass is a very durable and versatile material, with some key advantages:

- **Security.** Brass is not only stable, but also has a certain flexibility. Even the old time sailors appreciated not only the pressure- but also the impact resistance: great advantages over more rough metals.
- **Finishes.** In addition to the very good attributes for corrosion resistance, brass can be polished excellently and especially refined with plating finishes, e.g. with chrome. Accordingly, brass is widely used in the sanitary industry as a base material for fittings.
- **Custom Manufacturing.** Brass can be easily machined and processed with the right manufacturing equipment and at the same time offers the best conditions for a wide variety of finishes.

We do not only focus on high quality when selecting the materials. To this day, manual work is a guarantee of good quality - and rightly so. Our products are almost exclusively made by hand in our factory in Waldbroel, Germany. Material selection and on-site production also serve sustainability, a key goal of our company.

Our team, consisting of engineers, masters and glass technicians, is always working to perfect our products in terms of functionality and design. We are also happy to be your contact for the production of special solutions or the planning of complex projects and support you with our expertise.



5 JAHRE GARANTIE

5 YEAR WARRANTY

MADE IN GERMANY



5 JAHRE HERSTELLERGARANTIE AUF FOLGENDE PRODUKTE:

5 YEAR MANUFACTURER WARRANTY FOR THE FOLLOWING PRODUCTS:

Wellness, Wellness Premium, Wellness HS, Wellness HS CL, Fit, Next HS, Next HS CL, Milano Original Premium,
Milano Original, Milano, Milano Pur, Chalet AT, Chalet PT, Stratego, Filigrano, Türgriffe Door Handles

DUSCHTÜR BESCHLÄGE

SHOWER DOOR HINGES









ANSCHLAGTÜRSYSTEME

SINGLE ACTION DOOR SYSTEMS

	Wellness	02
	Wellness Premium	05
	Wellness HS	08
	Wellness HS CL	11
	CLASSTEC® Bella	13

PENDELTÜRSYSTEME

DOUBLE ACTION DOOR SYSTEMS

	Fit	14
	Milano	15
	Milano Pur	18
	Milano Original	22
	Milano Original Premium	24
	Next HS	25
	Next HS CL	26
	CLASSTEC® Vital	27

CLASSTEC®

2 JAHRE GARANTIE

2 YEAR WARRANTY







2 JAHRE HERSTELLERGARANTIE AUF FOLGENDE PRODUKTE:
2 YEAR MANUFACTURER WARRANTY FOR THE FOLLOWING PRODUCTS:

CLASSTEC® Bella, CLASSTEC® Vital

ZUBEHÖR

ACCESSORIES

	Stabilisationsstangen & Handtuchhalter Support & Towel Bars	29
	Türgriffe Door Handles	36
	Dichtprofile Seals	38
	Schwallschutz Threshold	42
	Trägerprofile & Anschlag Wall Attachment & Stoppers	43
	U-Profile & Werkzeuge U-Channels & Tools	44
	Ausgleichsadapter Distance adapter	45

GLASTÜRBESCHLÄGE

GLASS DOOR HINGES

ANSCHLAGTÜRSYSTEM

SINGLE ACTION DOOR SYSTEM

	Chalet AT	46
---	-----------	----

PENDELTÜRSYSTEM

DOUBLE ACTION DOOR SYSTEM

	Chalet PT	47
---	-----------	----

SCHRAUBEN & MONTAGEHILFEN

SCREWS & ASSEMBLY AID 48

ALLGEMEINE

GESCHÄFTSBEDINGUNGEN 49

GENERAL TERMS & CONDITIONS







OBERFLÄCHEN, GRAVUR & VEREDELUNGEN 55



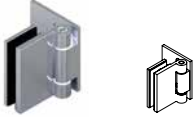

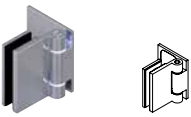
FINISHES & ENGRAVING

FUNKTIONEN
FEATURES

Nach innen oder außen öffnend
Durchgehende Dichtung (By-Pass-System)
Für Rundduschen und Falttüren geeignet
Basismaterial: Messing

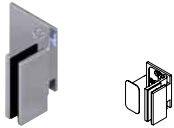
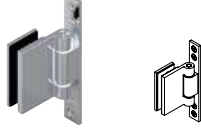
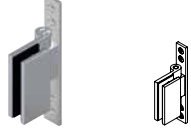
Opening in- or outwards
Continuous seal (By-Pass-System)
Suitable for round showers and folding doors
Base material: Brass

Art.-Nr.: Art. No.:												
06410	Duschtürbeschlag, G-W 90° Nach außen öffnend Für 8 mm ESG Shower door hinge, g-w 90° Opens outwards For 8 mm tempered glass	06411	Duschtürbeschlag, G-W 90° Nach innen öffnend Für 8 mm ESG Shower door hinge, g-w 90° Opens inwards For 8 mm tempered glass	06412	Duschtürbeschlag, G-W 90° Nach außen öffnend, Mit Langloch- anschraubplatte mit Abdeckung aus hochwertigem Edelstahl Für 8 mm ESG Shower door hinge, g-w 90° Opens outwards, With slotted hole screw plate with stainless steel cover For 8 mm tempered glass							
€ Stückpreis Price per piece	100 Stk. pcs.	50 Stk. pcs.	20 Stk. pcs.	1 Stk. pc.	100 Stk. pcs.	50 Stk. pcs.	20 Stk. pcs.	1 Stk. pc.	100 Stk. pcs.	50 Stk. pcs.	20 Stk. pcs.	1 Stk. pc.
	65,45	72,00	76,00	80,00	65,45	72,00	76,00	80,00	-	-	-	99,50
	75,27	82,80	87,40	92,00	75,27	82,80	87,40	92,00	-	-	-	115,00
	81,82	90,00	95,00	100,00	81,82	90,00	95,00	100,00	-	-	-	125,00



Art.-Nr.: Art. No.:												
06413	Duschtürbeschlag, G-W 90° Nach innen öffnend, Mit Langloch- anschraubplatte mit Abdeckung aus hochwertigem Edelstahl Für 8 mm ESG Shower door hinge, g-w 90° Opens inwards, With slotted hole screw plate with stainless steel cover For 8 mm tempered glass	06415	Duschtürbeschlag, G-W 90° Nach außen öffnend Für 8 mm ESG Shower door hinge, g-w 90° Opens outwards For 8 mm tempered glass	06416	Duschtürbeschlag, G-W 90° Nach innen öffnend Für 8 mm ESG Shower door hinge, g-w 90° Opens inwards For 8 mm tempered glass							
€ Stückpreis Price per piece	100 Stk. pcs.	50 Stk. pcs.	20 Stk. pcs.	1 Stk. pc.	100 Stk. pcs.	50 Stk. pcs.	20 Stk. pcs.	1 Stk. pc.	100 Stk. pcs.	50 Stk. pcs.	20 Stk. pcs.	1 Stk. pc.
	-	-	-	99,50	66,27	72,90	76,95	81,00	66,27	72,90	76,95	81,00
	-	-	-	115,00	76,91	84,60	89,30	94,00	76,91	84,60	89,30	94,00
	-	-	-	135,00	83,05	91,35	96,43	101,50	83,05	91,35	96,43	101,50

Art.-Nr.: Art. No.:		06430	Art.-Nr.: Art. No.:		06431	Art.-Nr.: Art. No.:		06460
Duschtürbeschlag, G-G 180° Nach außen öffnend Für 8 mm ESG Shower door hinge, g-g 180° Opens outwards For 8 mm tempered glass		Duschtürbeschlag, G-G 180° & 90° Jeweils nach innen öffnend Für 8 mm ESG Shower door hinge, g-g 180° & 90° Each opens inwards For 8 mm tempered glass		Duschtürbeschlag, G-W 135° Nach außen öffnend Für 8 mm ESG Shower door hinge, g-w 135° Opens outwards For 8 mm tempered glass				

€ Stückpreis Price per piece	100 Stk. pcs.	50 Stk. pcs.	20 Stk. pcs.	1 Stk. pc.
31	112,91	124,20	131,10	138,00
46	124,77	137,25	144,88	152,50
55	131,32	144,45	152,48	160,50

100 Stk. pcs.	50 Stk. pcs.	20 Stk. pcs.	1 Stk. pc.
112,91	124,20	131,10	138,00
124,77	137,25	144,88	152,50
131,32	144,45	152,48	160,50

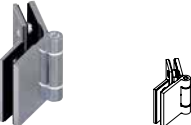

100 Stk. pcs.	50 Stk. pcs.	20 Stk. pcs.	1 Stk. pc.
-	-	-	144,00
-	-	-	-
-	-	-	-

Art.-Nr.: Art. No.:		06470	Art.-Nr.: Art. No.:		06471	Art.-Nr.: Art. No.:		06473
Duschtürbeschlag, G-G 135° Nach außen öffnend Für 8 mm ESG Shower door hinge, g-g 135° Opens outwards For 8 mm tempered glass		Längsverbinder, G-W 180° Für 8 mm ESG Connector, g-w 180° For 8 mm tempered glass		Längsverbinder, G-G 180° Für 8 mm ESG Connector, g-g 180° For 8 mm tempered glass				

€ Stückpreis Price per piece	100 Stk. pcs.	50 Stk. pcs.	20 Stk. pcs.	1 Stk. pc.
31	117,82	129,60	136,80	144,00
46	132,14	145,35	153,43	161,50
55	136,23	149,85	158,18	166,50

100 Stk. pcs.	50 Stk. pcs.	20 Stk. pcs.	1 Stk. pc.
51,55	56,70	59,85	63,00
54,82	60,30	63,65	67,00
58,50	64,35	67,93	71,50

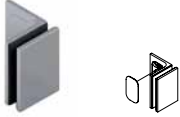
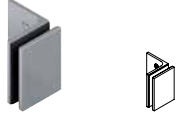
100 Stk. pcs.	50 Stk. pcs.	20 Stk. pcs.	1 Stk. pc.
73,64	81,00	85,50	90,00
83,45	91,80	96,90	102,00
89,18	98,10	103,55	109,00

<p>Art.-Nr.: Art. No.:</p>		<p>06480</p>	<p>Art.-Nr.: Art. No.:</p>		<p>06481</p>	<p>Art.-Nr.: Art. No.:</p>		<p>06483</p>
<p>Winkelverbinder, G-W 90° Mit Langlochschraubplatte mit Abdeckung aus hochwertigem Edelstahl Für 8 mm ESG</p> <p>Connector, g-w 90° With slotted hole screw plate with stainless steel cover For 8 mm tempered glass</p>		<p>Winkelverbinder, G-W 90° Für 8 mm ESG</p> <p>Connector, g-w 90° For 8 mm tempered glass</p>		<p>Winkelverbinder, G-G 90° Für 8 mm ESG</p> <p>Connector, g-g 90° For 8 mm tempered glass</p>				

€ Stückpreis Price per piece	100 Stk. pcs.	50 Stk. pcs.	20 Stk. pcs.	1 Stk. pc.
31	47,45	52,50	55,10	58,00
46	-	-	-	68,00
55	60,55	66,60	70,30	74,00

100 Stk. pcs.	50 Stk. pcs.	20 Stk. pcs.	1 Stk. pc.
40,50	44,55	47,03	49,50
42,55	46,80	49,40	52,00
46,64	51,30	54,15	57,00

100 Stk. pcs.	50 Stk. pcs.	20 Stk. pcs.	1 Stk. pc.
48,68	53,55	56,53	59,50
51,55	56,70	59,85	63,00
54,82	60,30	63,65	67,00

<p>Art.-Nr.: Art. No.:</p>		<p>06485</p>	<p>Art.-Nr.: Art. No.:</p>		<p>06487</p>
<p>Winkelverbinder, G-W 135° Für 8 mm ESG</p> <p>Connector, g-w 135° For 8 mm tempered glass</p>		<p>Winkelverbinder, G-G 135° Für 8 mm ESG</p> <p>Connector, g-g 135° For 8 mm tempered glass</p>			

€ Stückpreis Price per piece	100 Stk. pcs.	50 Stk. pcs.	20 Stk. pcs.	1 Stk. pc.
31	73,64	81,00	85,50	90,00
46	77,73	85,50	90,25	95,00
55	89,18	98,10	103,55	109,00

100 Stk. pcs.	50 Stk. pcs.	20 Stk. pcs.	1 Stk. pc.
78,55	86,40	91,20	96,00
82,64	90,90	95,95	101,00
98,59	108,45	114,48	120,50

WELLNESS PREMIUM

ANSCHLAGTÜRSYSTEM
SINGLE ACTION DOOR SYSTEM

FUNKTIONEN
FEATURES

Einstellbare Nulllage
Durchgehende Dichtung (By-Pass-System)
Für Rundduschen und Falttüren geeignet
Basismaterial: Messing

Adjustable index position
Continuous seal (By-Pass-System)
Suitable for round showers and folding doors
Base material: Brass

Art.-Nr.: Art. No.:		16410		16411		16412

€ Stückpreis Price per piece	100 Stk. pcs.	50 Stk. pcs.	20 Stk. pcs.	1 Stk. pc.
31	81,41	89,55	94,53	99,50
46	-	-	-	114,00
55	97,36	107,10	113,05	119,00

100 Stk. pcs.	50 Stk. pcs.	20 Stk. pcs.	1 Stk. pc.
81,41	89,55	94,53	99,50
-	-	-	114,00
97,36	107,10	113,05	119,00

100 Stk. pcs.	50 Stk. pcs.	20 Stk. pcs.	1 Stk. pc.
81,41	89,55	94,53	99,50
-	-	-	114,00
97,36	107,10	113,05	119,00

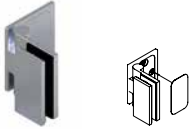
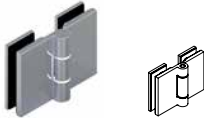
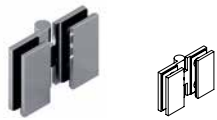
Art.-Nr.: Art. No.:		16413		16430		16431

€ Stückpreis Price per piece	100 Stk. pcs.	50 Stk. pcs.	20 Stk. pcs.	1 Stk. pc.
31	81,41	89,55	94,53	99,50
46	-	-	-	114,00
55	97,36	107,10	113,05	119,00

100 Stk. pcs.	50 Stk. pcs.	20 Stk. pcs.	1 Stk. pc.
124,77	137,25	144,88	152,50
128,05	140,85	148,68	156,50
139,50	153,45	161,98	170,50



100 Stk. pcs.	50 Stk. pcs.	20 Stk. pcs.	1 Stk. pc.
124,77	137,25	144,88	152,50
128,05	140,85	148,68	156,50
139,50	153,45	161,98	170,50

Art.-Nr.: Art. No.:			
	16432	16433	16470
<p>Duschtürbeschlag, G-G 180°, DIN-links Nach außen öffnend Für 8 mm ESG</p> <p>Shower door hinge, g-g 180°, EN-left Opens outwards For 8 mm tempered glass</p>		<p>Duschtürbeschlag, G-G 180° & 90° DIN-rechts Jeweils nach innen öffnend Für 8 mm ESG</p> <p>Shower door hinge, g-g 180° & 90° EN-right Each opens inwards For 8 mm tempered glass</p>	
<p>Duschtürbeschlag, G-G 135°, DIN-rechts Nach außen öffnend Für 8 mm ESG</p> <p>Shower door hinge, g-g 135°, EN-right Opens outwards For 8 mm tempered glass</p>			

€ Stückpreis Price per piece	100 Stk. pcs.	50 Stk. pcs.	20 Stk. pcs.	1 Stk. pc.
31	124,77	137,25	144,88	152,50
46	128,05	140,85	148,68	156,50
55	139,50	153,45	161,98	170,50

100 Stk. pcs.	50 Stk. pcs.	20 Stk. pcs.	1 Stk. pc.
124,77	137,25	144,88	152,50
128,05	140,85	148,68	156,50
139,50	153,45	161,98	170,50

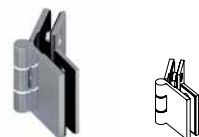
100 Stk. pcs.	50 Stk. pcs.	20 Stk. pcs.	1 Stk. pc.
135,00	148,50	156,75	165,00
139,09	153,00	161,50	170,00
156,27	171,90	181,45	191,00

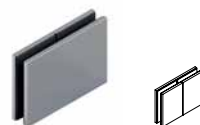
Art.-Nr.: Art. No.:			
	16472	06471	06473
<p>Duschtürbeschlag, G-G 135°, DIN-links Nach außen öffnend Für 8 mm ESG</p> <p>Shower door hinge, g-g 135°, EN-left Opens outwards For 8 mm tempered glass</p>		<p>Längsverbinder, G-W 180° Für 8 mm ESG</p> <p>Connector, g-w 180° For 8 mm tempered glass</p>	
		<p>Längsverbinder, G-G 180° Für 8 mm ESG</p> <p>Connector, g-g 180° For 8 mm tempered glass</p>	



€ Stückpreis Price per piece	100 Stk. pcs.	50 Stk. pcs.	20 Stk. pcs.	1 Stk. pc.
31	135,00	148,50	156,75	165,00
46	139,09	153,00	161,50	170,00
55	156,27	171,90	181,45	191,00

100 Stk. pcs.	50 Stk. pcs.	20 Stk. pcs.	1 Stk. pc.
51,55	56,70	59,85	63,00
54,82	60,30	63,65	67,00
58,50	64,35	67,93	71,50

100 Stk. pcs.	50 Stk. pcs.	20 Stk. pcs.	1 Stk. pc.
73,64	81,00	85,50	90,00
83,45	91,80	96,90	102,00
89,18	98,10	103,55	109,00

WELLNESS PREMIUM

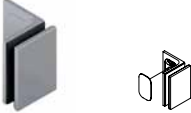
ANSCHLAGTÜRSYSTEM
SINGLE ACTION DOOR SYSTEM

Art.-Nr.: Art. No.:		06480	Art.-Nr.: Art. No.:		06481	Art.-Nr.: Art. No.:		06483
Winkelverbinder, G-W 90° Mit Langlochanschraubplatte mit Abdeckung aus hochwertigem Edelstahl Für 8 mm ESG Connector, g-w 90° With slotted hole screw plate with stainless steel cover For 8 mm tempered glass			Winkelverbinder, G-W 90° Für 8 mm ESG Connector, g-w 90° For 8 mm tempered glass			Winkelverbinder, G-G 90° Für 8 mm ESG Connector, g-g 90° For 8 mm tempered glass		

€ Stückpreis Price per piece	100 Stk. pcs.	50 Stk. pcs.	20 Stk. pcs.	1 Stk. pc.
31	47,45	52,20	55,10	58,00
46	-	-	-	68,00
55	60,55	66,60	70,30	74,00

100 Stk. pcs.	50 Stk. pcs.	20 Stk. pcs.	1 Stk. pc.
40,50	44,55	47,03	49,50
42,55	46,80	49,40	52,00
46,64	51,30	54,15	57,00

100 Stk. pcs.	50 Stk. pcs.	20 Stk. pcs.	1 Stk. pc.
48,68	53,55	56,53	59,50
51,55	56,70	59,85	63,00
54,82	60,30	63,65	67,00

Art.-Nr.: Art. No.:		06485	Art.-Nr.: Art. No.:		06487
Winkelverbinder, G-W 135° Für 8 mm ESG Connector, g-w 135° For 8 mm tempered glass			Winkelverbinder, G-G 135° Für 8 mm ESG Connector, g-g 135° For 8 mm tempered glass		



€ Stückpreis Price per piece	100 Stk. pcs.	50 Stk. pcs.	20 Stk. pcs.	1 Stk. pc.
31	73,64	81,00	85,50	90,00
46	77,73	85,50	90,25	95,00
55	89,18	98,10	103,55	109,00



100 Stk. pcs.	50 Stk. pcs.	20 Stk. pcs.	1 Stk. pc.
78,55	86,40	91,20	96,00
82,64	90,90	95,95	101,00
98,59	108,45	114,48	120,50

FUNKTIONEN
FEATURES

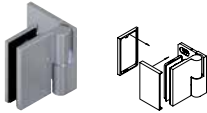
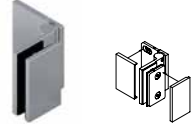
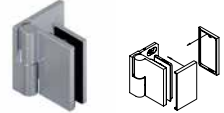

Einstellbare Nulllage
Durchgehende Dichtung (By-Pass-System)
Hebe-Senk-Mechanismus
Vollabgedeckte Verschraubung
Basismaterial: Messing

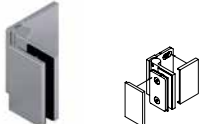
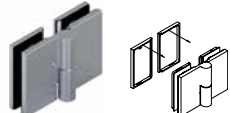
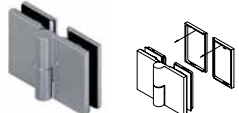
Adjustable index position
Continuous seal (By-Pass-System)
Gravity based lifting hinge
Covered backplate, no visible screws
Base material: Brass

Art.-Nr.: Art. No.:												
08310	Duschtürbeschlag, G-W 90°, DIN-rechts Mit Langlochanschraubplatte Nach außen öffnend Für 8 mm ESG Shower door hinge, g-w 90°, EN-right With slotted hole screw plate Opens outwards For 8 mm tempered glass	08311	Duschtürbeschlag, G-W 90°, DIN-rechts Mit Langlochanschraubplatte Nach innen öffnend Für 8 mm ESG Shower door hinge, g-w 90°, EN-right With slotted hole screw plate Opens inwards For 8 mm tempered glass	08312	Duschtürbeschlag, G-W 90°, DIN-links Mit Langlochanschraubplatte Nach außen öffnend Für 8 mm ESG Shower door hinge, g-w 90°, EN-left With slotted hole screw plate Opens outwards For 8 mm tempered glass							
€ Stückpreis Price per piece	100 Stk. pcs.	50 Stk. pcs.	20 Stk. pcs.	1 Stk. pc.	100 Stk. pcs.	50 Stk. pcs.	20 Stk. pcs.	1 Stk. pc.	100 Stk. pcs.	50 Stk. pcs.	20 Stk. pcs.	1 Stk. pc.
	97,36	107,10	113,05	119,00	97,36	107,10	113,05	119,00	97,36	107,10	113,05	119,00
	113,73	125,10	132,05	139,00	113,73	125,10	132,05	139,00	113,73	125,10	132,05	139,00

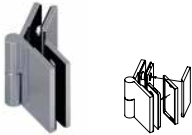

Art.-Nr.: Art. No.:												
08313	Duschtürbeschlag, G-W 90°, DIN-links Mit Langlochanschraubplatte Nach innen öffnend Für 8 mm ESG Shower door hinge, g-w 90°, EN-left With slotted hole screw plate Opens inwards For 8 mm tempered glass	08330	Duschtürbeschlag, G-G 180°, DIN-rechts Nach außen öffnend Für 8 mm ESG Shower door hinge, g-g 180°, EN-right Opens outwards For 8 mm tempered glass	08332	Duschtürbeschlag, G-G 180°, DIN-links Nach außen öffnend Für 8 mm ESG Shower door hinge, g-g 180°, EN-left Opens outwards For 8 mm tempered glass							
€ Stückpreis Price per piece	100 Stk. pcs.	50 Stk. pcs.	20 Stk. pcs.	1 Stk. pc.	100 Stk. pcs.	50 Stk. pcs.	20 Stk. pcs.	1 Stk. pc.	100 Stk. pcs.	50 Stk. pcs.	20 Stk. pcs.	1 Stk. pc.
	97,36	107,10	113,05	119,00	117,82	129,60	136,80	144,00	117,82	129,60	136,80	144,00
	113,73	125,10	132,05	139,00	130,91	144,00	152,00	160,00	130,91	144,00	152,00	160,00



Art.-Nr.: Art. No.:			
	08370	08372	06471
	Duschtürbeschlag, G-G 135°, DIN-rechts Nach außen öffnend Für 8 mm ESG Shower door hinge, g-g 135°, EN-right Opens outwards For 8 mm tempered glass	Duschtürbeschlag, G-G 135°, DIN-links Nach außen öffnend Für 8 mm ESG Shower door hinge, g-g 135°, EN-left Opens outwards For 8 mm tempered glass	Längsverbinder, G-W 180° Für 8 mm ESG Connector, g-w 180° For 8 mm tempered glass

€ Stückpreis Price per piece	100 Stk. pcs.	50 Stk. pcs.	20 Stk. pcs.	1 Stk. pc.
	128,45	141,30	149,15	157,00
	147,27	162,00	171,00	180,00

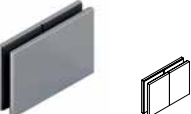
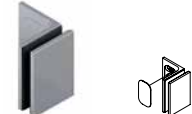
100 Stk. pcs.	50 Stk. pcs.	20 Stk. pcs.	1 Stk. pc.
128,45	141,30	149,15	157,00
147,27	162,00	171,00	180,00



100 Stk. pcs.	50 Stk. pcs.	20 Stk. pcs.	1 Stk. pc.
51,55	56,70	59,85	63,00
58,50	64,35	67,93	71,50



Art.-Nr.: Art. No.:			
	06473	06480	06481
	Längsverbinder, G-G 180° Für 8 mm ESG Connector, g-g 180° For 8 mm tempered glass	Winkelverbinder, G-W 90° Mit Langlochanschraubplatte mit Abdeckung aus hochwertigem Edelstahl Für 8 mm ESG Connector, g-w 90° With slotted hole screw plate with stainless steel cover For 8 mm tempered glass	Winkelverbinder, G-W 90° Für 8 mm ESG Connector, g-w 90° For 8 mm tempered glass

€ Stückpreis Price per piece	100 Stk. pcs.	50 Stk. pcs.	20 Stk. pcs.	1 Stk. pc.
	73,64	81,00	85,50	90,00
	89,18	98,10	103,55	109,00

100 Stk. pcs.	50 Stk. pcs.	20 Stk. pcs.	1 Stk. pc.
47,45	52,20	55,10	58,00
60,55	66,60	70,30	74,00

100 Stk. pcs.	50 Stk. pcs.	20 Stk. pcs.	1 Stk. pc.
40,50	44,55	47,03	49,50
46,64	51,30	54,15	57,00

Art.-Nr.: Art. No.:						
	06483	06485	06487			
	Winkelverbinder, G-G 90° Für 8 mm ESG Connector, g-g 90° For 8 mm tempered glass		Winkelverbinder, G-W 135° Für 8 mm ESG Connector, g-w 135° For 8 mm tempered glass		Winkelverbinder, G-G 135° Für 8 mm ESG Connector, g-g 135° For 8 mm tempered glass	

€ Stückpreis Price per piece	100 Stk. pcs.	50 Stk. pcs.	20 Stk. pcs.	1 Stk. pc.
	48,68	53,55	56,53	59,50
	54,82	60,30	63,65	67,00

100 Stk. pcs.	50 Stk. pcs.	20 Stk. pcs.	1 Stk. pc.
73,64	81,00	85,50	90,00
89,18	98,10	103,55	109,00

100 Stk. pcs.	50 Stk. pcs.	20 Stk. pcs.	1 Stk. pc.
78,55	86,40	91,20	96,00
98,59	108,45	114,48	120,50



WELLNESS HS CL

ANSCHLAGTÜRSYSTEM
SINGLE ACTION DOOR SYSTEM

FUNKTIONEN
FEATURES



Einstellbare Nulllage
Flächenbündige Verschraubung
Durchgehende Dichtung (By-Pass-System)
Hebe-Senk-Mechanismus
Basismaterial: Messing

Adjustable index position
Countersunk screws
Continuous seal (By-Pass-System)
Gravity based lifting hinge
Base material: Brass





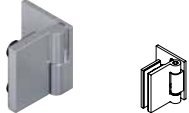

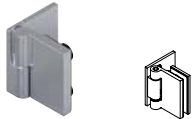
Notwendiges Montagewerkzeug (Art.-Nr. 81499) finden Sie auf Seite 44

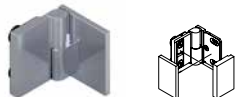
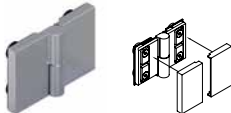
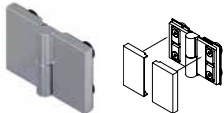
You will find the required assembly tool (art. no. 81499) on page 44



Art.-Nr. Art. No.:	08410	08411	08412									
												
	Duschtürbeschlag, G-W 90°, DIN-rechts Mit Langlochanschraubplatte Nach außen öffnend Für 8 mm ESG Shower door hinge, g-w 90°, EN-right With slotted hole screw plate Opens outwards For 8 mm tempered glass	Duschtürbeschlag, G-W 90°, DIN-links Mit Langlochanschraubplatte außen Nach außen öffnend Für 8 mm ESG Shower door hinge, g-w 90°, EN-left With slotted hole screw plate outside Opens outwards For 8 mm tempered glass	Duschtürbeschlag, G-W 90°, DIN-links Mit Langlochanschraubplatte Nach außen öffnend Für 8 mm ESG Shower door hinge, g-w 90°, EN-left With slotted hole screw plate Opens outwards For 8 mm tempered glass									
€ Stückpreis Price per piece	100 Stk. pcs.	50 Stk. pcs.	20 Stk. pcs.	1 Stk. pc.	100 Stk. pcs.	50 Stk. pcs.	20 Stk. pcs.	1 Stk. pc.	100 Stk. pcs.	50 Stk. pcs.	20 Stk. pcs.	1 Stk. pc.
31	85,91	94,50	99,75	105,00	85,91	94,50	99,75	105,00	85,91	94,50	99,75	105,00

Art.-Nr. Art. No.:	08413	08430	08432									
												
	Duschtürbeschlag, G-W 90°, DIN-rechts Mit Langlochanschraubplatte außen Nach außen öffnend Für 8 mm ESG Shower door hinge, g-w 90°, EN-right With slotted hole screw plate outside Opens outwards For 8 mm tempered glass	Duschtürbeschlag, G-G 180°, DIN-rechts Nach außen öffnend Für 8 mm ESG Shower door hinge, g-g 180°, EN-right Opens outwards For 8 mm tempered glass	Duschtürbeschlag, G-G 180°, DIN-links Nach außen öffnend Für 8 mm ESG Shower door hinge, g-g 180°, EN-left Opens outwards For 8 mm tempered glass									
€ Stückpreis Price per piece	100 Stk. pcs.	50 Stk. pcs.	20 Stk. pcs.	1 Stk. pc.	100 Stk. pcs.	50 Stk. pcs.	20 Stk. pcs.	1 Stk. pc.	100 Stk. pcs.	50 Stk. pcs.	20 Stk. pcs.	1 Stk. pc.
31	85,91	94,50	99,75	105,00	118,64	130,50	137,75	145,00	118,64	130,50	137,75	145,00

Art.-Nr.: Art. No.:	 	 	 																										
08480	08481	08483																											
<p>Winkelverbinder, G-W 90° Mit Langlochanschraubplatte Für 8 mm ESG</p> <p>Connector, g-w 90° With slotted hole screw plate For 8 mm tempered glass</p>	<p>Winkelverbinder, G-W 90° Mit Langlochanschraubplatte nach außen Für 8 mm ESG</p> <p>Connector, g-w 90° With slotted hole screw plate outside For 8 mm tempered glass</p>	<p>Winkelverbinder, G-G 90° Für 8 mm ESG</p> <p>Connector, g-g 90° For 8 mm tempered glass</p>																											
<table border="1"> <thead> <tr> <th>€ Stückpreis Price per piece</th> <th>100 Stk. pcs.</th> <th>50 Stk. pcs.</th> <th>20 Stk. pcs.</th> <th>1 Stk. pc.</th> </tr> </thead> <tbody> <tr> <td>31</td> <td>58,91</td> <td>64,80</td> <td>68,40</td> <td>72,00</td> </tr> </tbody> </table>	€ Stückpreis Price per piece	100 Stk. pcs.	50 Stk. pcs.	20 Stk. pcs.	1 Stk. pc.	31	58,91	64,80	68,40	72,00	<table border="1"> <thead> <tr> <th>100 Stk. pcs.</th> <th>50 Stk. pcs.</th> <th>20 Stk. pcs.</th> <th>1 Stk. pc.</th> </tr> </thead> <tbody> <tr> <td>58,91</td> <td>64,80</td> <td>68,40</td> <td>72,00</td> </tr> </tbody> </table>	100 Stk. pcs.	50 Stk. pcs.	20 Stk. pcs.	1 Stk. pc.	58,91	64,80	68,40	72,00	<table border="1"> <thead> <tr> <th>100 Stk. pcs.</th> <th>50 Stk. pcs.</th> <th>20 Stk. pcs.</th> <th>1 Stk. pc.</th> </tr> </thead> <tbody> <tr> <td>65,45</td> <td>72,00</td> <td>76,00</td> <td>80,00</td> </tr> </tbody> </table>	100 Stk. pcs.	50 Stk. pcs.	20 Stk. pcs.	1 Stk. pc.	65,45	72,00	76,00	80,00	
€ Stückpreis Price per piece	100 Stk. pcs.	50 Stk. pcs.	20 Stk. pcs.	1 Stk. pc.																									
31	58,91	64,80	68,40	72,00																									
100 Stk. pcs.	50 Stk. pcs.	20 Stk. pcs.	1 Stk. pc.																										
58,91	64,80	68,40	72,00																										
100 Stk. pcs.	50 Stk. pcs.	20 Stk. pcs.	1 Stk. pc.																										
65,45	72,00	76,00	80,00																										















FUNKTIONEN
FEATURES

Vollabgedeckte Verschraubung
Basismaterial: Messing

Covered backplate
Base material: Brass





Art.-Nr. Art. No.:			Art.-Nr. Art. No.:			Art.-Nr. Art. No.:		
81012	<p>Duschtürbeschlag, G-W 90° Mit Langlochanschraubplatte Nach außen öffnend Für 8 mm ESG</p> <p>Shower door hinge, g-w 90° With slotted hole screw plate Opens outwards For 8 mm tempered glass</p>		81013	<p>Duschtürbeschlag, G-W 90° Mit Langlochanschraubplatte Nach innen öffnend Für 8 mm ESG</p> <p>Shower door hinge, g-w 90° With slotted hole screw plate Opens inwards For 8 mm tempered glass</p>		81014	<p>Duschtürbeschlag, G-W 90° Durchgehende Dichtung (By-Pass-System) Mit Langlochanschraubplatte und Nut Nach außen öffnend, Für 8 mm ESG</p> <p>Shower door hinge, g-w 90° Continuous seal (By-Pass-System) With slotted hole screw plate and notch Opens outwards, For 8 mm tempered glass</p>	
€ Stückpreis Price per piece	100 Stk. pcs.	50 Stk. pcs.	20 Stk. pcs.	1 Stk. pc.	100 Stk. pcs.	50 Stk. pcs.	20 Stk. pcs.	1 Stk. pc.
31	45,00	48,00	52,00	56,00	45,00	48,00	52,00	56,00
81030			81080			81083		
Art.-Nr. Art. No.:	<p>Duschtürbeschlag, G-G 90°, nach innen öffnend oder 180° nach außen oder innen öffnend Für 8 mm ESG</p> <p>Shower door hinge, g-g 90°, opens inwards or 180° out- or inwards For 8 mm tempered glass</p>		Art.-Nr. Art. No.:	<p>Winkelverbinder, G-W 90° Mit Langlochanschraubplatte Für 8 mm ESG</p> <p>Connector, g-w 90° With slotted hole screw plate For 8 mm tempered glass</p>		Art.-Nr. Art. No.:	<p>Winkelverbinder, G-G 90° Für 8 mm ESG</p> <p>Connector, g-g 90° For 8 mm tempered glass</p>	
€ Stückpreis Price per piece	100 Stk. pcs.	50 Stk. pcs.	20 Stk. pcs.	1 Stk. pc.	100 Stk. pcs.	50 Stk. pcs.	20 Stk. pcs.	1 Stk. pc.
31	65,00	70,00	74,00	78,00	35,00	37,00	38,50	39,50
	43,00	44,00	44,50	45,00				

FUNKTIONEN
FEATURES

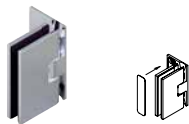
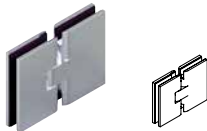

Einstellbare Nulllage
In das Band integrierte Dichtung
Als Saunavariante erhältlich
Basismaterial: Messing



Adjustable index position
Integrated seal in hinge
Sauna type hinge available
Base material: Brass

Art.-Nr.: Art. No.:		
07210	Duschtürbeschlag, G-W 90° Mit Langlochanschraubplatte mit Abdeckung aus hochwertigem Edelstahl Beidseitig öffnend, Für 8 mm ESG Shower door hinge, g-w 90° With slotted hole screw plate with stainless steel cover plate Double action, For 8 mm tempered glass	07230
€ Stückpreis Price per piece	1 Stk. pc.	1 Stk. pc.
	112,00	161,00
	142,00	181,00

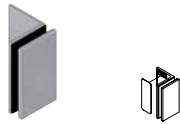
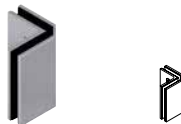
**DEMNÄCHST
LIEFERBAR**
AVAILABLE
SOON

**DEMNÄCHST
LIEFERBAR**
AVAILABLE
SOON

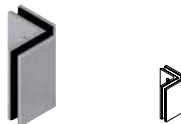
Art.-Nr.: Art. No.:				
94482	Winkelverbinder, G-W 90° Mit Langlochanschraubplatte mit Abdeckung aus hochwertigem Edelstahl Für 8 mm ESG Connector, g-w 90° With slotted hole screw plate with stainless steel cover plate For 8 mm tempered glass	94483		
€ Stückpreis Price per piece	100 Stk. pcs.	50 Stk. pcs.	20 Stk. pcs.	1 Stk. pc.
	29,00	35,00	39,00	41,00

Art.-Nr.: Art. No.:				
94483	Winkelverbinder, G-G 90° Für 8 mm ESG Connector, g-g 90° For 8 mm tempered glass			
€ Stückpreis Price per piece	100 Stk. pcs.	50 Stk. pcs.	20 Stk. pcs.	1 Stk. pc.
	36,00	39,00	43,00	45,00

FUNKTIONEN
FEATURES

Einstellbare Nulllage
Basismaterial: Messing







Adjustable index position
Base material: Brass

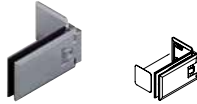
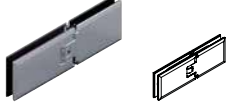

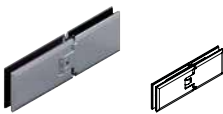







¹⁾ Rolle aus hochwertigem Edelstahl

¹⁾ Stainless steel cylinder



Art.-Nr.: Art. No.:	06110	06112	06130
			
	<p>Duschtürbeschlag, G-W 90° Beidseitig öffnend Für 8 & 10 mm ESG</p> <p>Shower door hinge, g-w 90° Double action For 8 & 10 mm tempered glass</p>	<p>Duschtürbeschlag, G-W 90° Mit Langlochanschraubplatte mit Abdeckung aus hochwertigem Edelstahl Beidseitig öffnend, Für 8 & 10 mm ESG</p> <p>Shower door hinge, g-w 90° With slotted hole screw plate with stainless steel cover Double action For 8 & 10 mm tempered glass</p>	<p>Duschtürbeschlag, G-G 180° Beidseitig öffnend Für 8 & 10 mm ESG</p> <p>Shower door hinge, g-g 180° Double action For 8 & 10 mm tempered glass</p>
€ Stückpreis Price per piece	1 Stk. pc.	1 Stk. pc.	1 Stk. pc.
31	97,00	112,00	161,00
46	119,00	-	181,00
55 ¹⁾	131,00	151,00	191,00
65	97,00	112,00	161,00

Art.-Nr.: Art. No.:			
06132	Duschtürbeschlag, G-G 180° Mit Spritzschutz Einseitig öffnend, Für 8 & 10 mm ESG Shower door hinge, g-g 180° With splash guard Single action For 8 & 10 mm tempered glass	06800	06801
€ Stückpreis Price per piece	1 Stk. pc.	1 Stk. pc.	1 Stk. pc.
31	170,00	58,00	49,00
46	190,00	68,00	58,00
55 ¹⁾	200,00	71,00	61,00
65	170,00	58,00	49,00
Art.-Nr.: Art. No.:			
06803	Winkelverbinder, G-G 90° Für 8 & 10 mm ESG Connector, g-g 90° For 8 & 10 mm tempered glass	06805	06815
€ Stückpreis Price per piece	1 Stk. pc.	1 Stk. pc.	1 Stk. pc.
31	59,00	63,00	76,00
46	68,00	67,00	-
55	72,00	69,00	106,00
65	59,00	63,00	76,00

Art.-Nr.: Art. No.:	 	 	 
06816	<p>Winkelverbinder G-W, einstellbar von 90° – 180° Mit Langlochschraubplatte mit Abdeckung aus hochwertigem Edelstahl Für 8 & 10 mm ESG</p> <p>Connector, g-w, adjustable 90° – 180° With slotted hole screw plate with stainless steel cover For 8 & 10 mm tempered glass</p>	<p>Winkelverbinder G-G einstellbar von 45° – 180° Mit Langloch mit Abdeckung aus hochwertigem Edelstahl Für 8 & 10 mm ESG</p> <p>Connector, g-g, adjustable 45° – 180° With slotted hole screw with stainless steel cover For 8 & 10 mm tempered glass</p>	<p>Halteklammer Für 8 mm ESG</p> <p>Clamp For 8 mm tempered glass</p>
€ Stückpreis Price per piece	1 Stk. pc.	1 Stk. pc.	1 Stk. pc.
	76,00	79,00	44,00
	-	-	-
	106,00	107,00	51,00
	76,00	79,00	44,00















FUNKTIONEN
FEATURES

Einstellbare Nulllage
Basismaterial: Messing

Adjustable index position
Base material: Brass

¹⁾ Rolle aus hochwertigem Edelstahl

¹⁾ Stainless steel cylinder

Art.-Nr. Art. No.:			Art.-Nr. Art. No.:			Art.-Nr. Art. No.:		
07110	<p>Duschtürbeschlag, G-W 90° Beidseitig öffnend Für 8 & 10 mm ESG</p> <p>Shower door hinge, g-w 90° Double action For 8 & 10 mm tempered glass</p>		07112	<p>Duschtürbeschlag, G-W 90° Mit Langlochanschraubplatte mit Abdeckung aus hochwertigem Edelstahl Beidseitig öffnend, Für 8 & 10 mm ESG</p> <p>Shower door hinge, g-w 90° With slotted hole screw plate with stainless steel cover Double action For 8 & 10 mm tempered glass</p>		07115	<p>Duschtürbeschlag, G-W 90° Beidseitig öffnend Für 8 & 10 mm ESG</p> <p>Shower door hinge, g-w 90° Double action For 8 & 10 mm tempered glass</p>	
€ Stückpreis Price per piece	100 Stk. pcs.	50 Stk. pcs.	20 Stk. pcs.	1 Stk. pc.	100 Stk. pcs.	50 Stk. pcs.	20 Stk. pcs.	1 Stk. pc.
	82,64	90,90	95,95	101,00	85,91	94,50	99,75	105,00
 ¹⁾	115,36	126,90	133,95	141,00	116,18	127,80	134,90	142,00
	82,64	90,90	95,95	101,00	85,91	94,50	99,75	105,00
07120	<p>Duschtürbeschlag, G-W 90° Beidseitig öffnend Für 8 & 10 mm ESG</p> <p>Shower door hinge, g-w 90° Double action For 8 & 10 mm tempered glass</p>		07130	<p>Duschtürbeschlag, G-G 180° Beidseitig öffnend Für 8 & 10 mm ESG</p> <p>Shower door hinge, g-g 180° Double action For 8 & 10 mm tempered glass</p>		07140	<p>Duschtürbeschlag, G-G 90° Beidseitig öffnend Für 8 & 10 mm ESG</p> <p>Shower door hinge, g-g 90° Double action For 8 & 10 mm tempered glass</p>	
€ Stückpreis Price per piece	100 Stk. pcs.	50 Stk. pcs.	20 Stk. pcs.	1 Stk. pc.	100 Stk. pcs.	50 Stk. pcs.	20 Stk. pcs.	1 Stk. pc.
	87,55	96,30	101,65	107,00	131,73	144,90	152,95	161,00
 ¹⁾	111,27	122,40	129,20	136,00	156,27	171,90	181,45	191,00
	87,55	96,30	101,65	107,00	131,73	144,90	152,95	161,00

MILANO PUR

PENDELTÜRSYSTEM
DOUBLE ACTION DOOR SYSTEM

¹⁾ Rolle aus hochwertigem Edelstahl

¹⁾ Stainless steel cylinder

Art.-Nr.: Art. No.:		07160	<p>Duschtürbeschlag, G-W 135° Beidseitig öffnend Sondergradzahl nach Rücksprache möglich Für 8 mm ESG</p> <p>Shower door hinge, g-w 135° Double action Special angle degree possible For 8 mm tempered glass</p>		07170	<p>Duschtürbeschlag, G-G 135° Beidseitig öffnend Sondergradzahl nach Rücksprache möglich Für 8 & 10 mm ESG</p> <p>Shower door hinge, g-g 135° Double action Special angle degree possible For 8 & 10 mm tempered glass</p>		07181	<p>Duschtürbeschlag, G-W 180° Beidseitig öffnend Für 8 & 10 mm ESG</p> <p>Shower door hinge, g-w 180° Double action For 8 & 10 mm tempered glass</p>

€ Stückpreis Price per piece	100 Stk. pcs.	50 Stk. pcs.	20 Stk. pcs.	1 Stk. pc.
31	143,18	157,50	166,25	175,00
55 ¹⁾	168,55	185,40	195,70	206,00
65	143,18	157,50	166,25	175,00

100 Stk. pcs.	50 Stk. pcs.	20 Stk. pcs.	1 Stk. pc.
154,64	170,10	179,55	189,00
182,45	200,70	211,85	223,00
154,64	170,10	179,55	189,00

100 Stk. pcs.	50 Stk. pcs.	20 Stk. pcs.	1 Stk. pc.
122,73	135,00	142,50	150,00
147,27	162,00	171,00	180,00
122,73	135,00	142,50	150,00

Art.-Nr.: Art. No.:		07182	<p>Duschtürbeschlag, G-W 180° Beidseitig öffnend Für 8 & 10 mm ESG</p> <p>Shower door hinge, g-w 180° Double action For 8 & 10 mm tempered glass</p>		07183	<p>Duschtürbeschlag, G-W 180° Beidseitig öffnend Für 8 & 10 mm ESG</p> <p>Shower door hinge, g-w 180° Double action For 8 & 10 mm tempered glass</p>		07184	<p>Duschtürbeschlag, G-W 180° Beidseitig öffnend Für 8 & 10 mm ESG</p> <p>Shower door hinge, g-w 180° Double action For 8 & 10 mm tempered glass</p>

€ Stückpreis Price per piece	100 Stk. pcs.	50 Stk. pcs.	20 Stk. pcs.	1 Stk. pc.
31	122,73	135,00	142,50	150,00
55 ¹⁾	147,27	162,00	171,00	180,00
65	122,73	135,00	142,50	150,00

100 Stk. pcs.	50 Stk. pcs.	20 Stk. pcs.	1 Stk. pc.
122,73	135,00	142,50	150,00
147,27	162,00	171,00	180,00
122,73	135,00	142,50	150,00

100 Stk. pcs.	50 Stk. pcs.	20 Stk. pcs.	1 Stk. pc.
122,73	135,00	142,50	150,00
147,27	162,00	171,00	180,00
122,73	135,00	142,50	150,00

¹⁾ Rolle aus hochwertigem Edelstahl



¹⁾ Stainless steel cylinder

Art.-Nr.: Art. No.:		07190		07191		07192
<p>Winkelverbinder, G-W 90° Mit Langlochschraubplatte mit Abdeckung aus hochwertigem Edelstahl Für 8 & 10 mm ESG</p> <p>Connector, g-w 90° With slotted hole screw plate with stainless steel cover For 8 & 10 mm tempered glass</p>		<p>Winkelverbinder, G-W 90° Für 8 & 10 mm ESG</p> <p>Connector, g-w 90° For 8 & 10 mm tempered glass</p>		<p>Längsverbinder, G-W 180° Für 8 & 10 mm ESG</p> <p>Connector, g-w 180° For 8 & 10 mm tempered glass</p>		

€ Stückpreis Price per piece	100 Stk. pcs.	50 Stk. pcs.	20 Stk. pcs.	1 Stk. pc.
31	47,45	52,20	55,10	58,00
55	58,09	63,90	67,45	71,00
65	47,45	52,20	55,10	58,00

100 Stk. pcs.	50 Stk. pcs.	20 Stk. pcs.	1 Stk. pc.
40,09	44,10	46,55	49,00
49,91	54,90	57,95	61,00
40,09	44,10	46,55	49,00

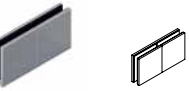













100 Stk. pcs.	50 Stk. pcs.	20 Stk. pcs.	1 Stk. pc.
59,73	65,70	69,35	73,00
65,45	72,00	76,00	80,00
59,73	65,70	69,35	73,00

Art.-Nr.: Art. No.:		07193		07194		07195
<p>Winkelverbinder, G-G 90° Für 8 & 10 mm ESG</p> <p>Connector, g-g 90° For 8 & 10 mm tempered glass</p>		<p>Längsverbinder, G-G 180° Für 8 & 10 mm ESG</p> <p>Connector, g-g 180° For 8 & 10 mm tempered glass</p>		<p>Winkelverbinder G-W, Einstellbar von 45° – 180° Mit Langlochschraubplatte mit Abdeckung aus hochwertigem Edelstahl Für 8 & 10 mm ESG</p> <p>Connector, g-w, adjustable 45° – 180° With slotted hole screw plate with stainless steel cover For 8 & 10 mm tempered glass</p>		

€ Stückpreis Price per piece	100 Stk. pcs.	50 Stk. pcs.	20 Stk. pcs.	1 Stk. pc.
31	48,27	53,10	56,05	59,00
55	54,82	60,30	63,65	67,00
65	48,27	53,10	56,05	59,00

100 Stk. pcs.	50 Stk. pcs.	20 Stk. pcs.	1 Stk. pc.
54,82	60,30	63,65	67,00
66,27	72,90	76,95	81,00
54,82	60,30	63,65	67,00

100 Stk. pcs.	50 Stk. pcs.	20 Stk. pcs.	1 Stk. pc.
62,18	68,40	72,20	76,00
86,73	95,40	100,70	106,00
62,18	68,40	72,20	76,00

Art.-Nr.: Art. No.:	 	 	 																																																			
07196	<p>Winkelverbinder G-W, Einstellbar von 90° – 180° Mit Langlochschraubplatte mit Abdeckung aus hochwertigem Edelstahl Für 8 & 10 mm ESG</p> <p>Connector, g-w, adjustable 90° – 180° With slotted hole screw plate with stainless steel cover For 8 & 10 mm tempered glass</p>	<p>Winkelverbinder G-G, Einstellbar von 45° – 180° Mit Langloch mit Abdeckung aus hochwertigem Edelstahl Für 8 & 10 mm ESG</p> <p>Connector, g-g, adjustable 45° – 180° With slotted hole screw with stainless steel cover For 8 & 10 mm tempered glass</p>	<p>Halteklammer Für 8 mm ESG</p> <p>Clamp For 8 mm tempered glass</p>																																																			
<table border="1"> <thead> <tr> <th>€ Stückpreis Price per piece</th> <th>100 Stk. pcs.</th> <th>50 Stk. pcs.</th> <th>20 Stk. pcs.</th> <th>1 Stk. pc.</th> </tr> </thead> <tbody> <tr> <td></td> <td>62,18</td> <td>68,40</td> <td>72,20</td> <td>76,00</td> </tr> <tr> <td></td> <td>86,73</td> <td>95,40</td> <td>100,70</td> <td>106,00</td> </tr> <tr> <td></td> <td>62,18</td> <td>68,40</td> <td>72,20</td> <td>76,00</td> </tr> </tbody> </table>	€ Stückpreis Price per piece	100 Stk. pcs.	50 Stk. pcs.	20 Stk. pcs.	1 Stk. pc.		62,18	68,40	72,20	76,00		86,73	95,40	100,70	106,00		62,18	68,40	72,20	76,00	<table border="1"> <thead> <tr> <th>100 Stk. pcs.</th> <th>50 Stk. pcs.</th> <th>20 Stk. pcs.</th> <th>1 Stk. pc.</th> </tr> </thead> <tbody> <tr> <td>64,64</td> <td>71,10</td> <td>75,05</td> <td>79,00</td> </tr> <tr> <td>87,55</td> <td>96,30</td> <td>101,65</td> <td>107,00</td> </tr> <tr> <td>64,64</td> <td>71,10</td> <td>75,05</td> <td>79,00</td> </tr> </tbody> </table>	100 Stk. pcs.	50 Stk. pcs.	20 Stk. pcs.	1 Stk. pc.	64,64	71,10	75,05	79,00	87,55	96,30	101,65	107,00	64,64	71,10	75,05	79,00	<table border="1"> <thead> <tr> <th>100 Stk. pcs.</th> <th>50 Stk. pcs.</th> <th>20 Stk. pcs.</th> <th>1 Stk. pc.</th> </tr> </thead> <tbody> <tr> <td>28,64</td> <td>31,50</td> <td>33,25</td> <td>35,00</td> </tr> <tr> <td>39,27</td> <td>43,20</td> <td>45,60</td> <td>48,00</td> </tr> <tr> <td>28,64</td> <td>31,50</td> <td>33,25</td> <td>35,00</td> </tr> </tbody> </table>	100 Stk. pcs.	50 Stk. pcs.	20 Stk. pcs.	1 Stk. pc.	28,64	31,50	33,25	35,00	39,27	43,20	45,60	48,00	28,64	31,50	33,25	35,00
€ Stückpreis Price per piece	100 Stk. pcs.	50 Stk. pcs.	20 Stk. pcs.	1 Stk. pc.																																																		
	62,18	68,40	72,20	76,00																																																		
	86,73	95,40	100,70	106,00																																																		
	62,18	68,40	72,20	76,00																																																		
100 Stk. pcs.	50 Stk. pcs.	20 Stk. pcs.	1 Stk. pc.																																																			
64,64	71,10	75,05	79,00																																																			
87,55	96,30	101,65	107,00																																																			
64,64	71,10	75,05	79,00																																																			
100 Stk. pcs.	50 Stk. pcs.	20 Stk. pcs.	1 Stk. pc.																																																			
28,64	31,50	33,25	35,00																																																			
39,27	43,20	45,60	48,00																																																			
28,64	31,50	33,25	35,00																																																			



MILANO ORIGINAL

FUNKTIONEN FEATURES

Einstellbare Nulllage
Vollabgedeckte Verschraubung
Als Saunavariante erhältlich
Basismaterial: Messing

Adjustable index position
Covered backplate
Sauna type hinge available
Base material: Brass

¹⁾ Rolle aus hochwertigem Edelstahl

¹⁾ Stainless steel cylinder

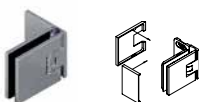
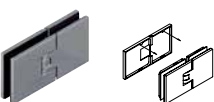
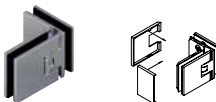
Art.-Nr.: Art. No.:					
07812	Duschtürbeschlag, G-W 90° Mit Langlochanschraubplatte Beidseitig öffnend Für 8 & 10 mm ESG Shower door hinge, g-w 90° With slotted hole screw plate Double action For 8 & 10 mm tempered glass	07830	Duschtürbeschlag, G-G 180° Beidseitig öffnend Für 8 & 10 mm ESG Shower door hinge, g-g 180° Double action For 8 & 10 mm tempered glass	07840	Duschtürbeschlag, G-G 90° Beidseitig öffnend Für 8 & 10 mm ESG Shower door hinge, g-g 90° Double action For 8 & 10 mm tempered glass

€ Stückpreis Price per piece	100 Stk. pcs.	50 Stk. pcs.	20 Stk. pcs.	1 Stk. pc.
31	89,00	99,00	109,00	115,00
55 ¹⁾	105,00	119,00	135,00	149,00
65	98,00	109,00	124,00	131,00

100 Stk. pcs.	50 Stk. pcs.	20 Stk. pcs.	1 Stk. pc.
118,00	128,00	133,00	138,00
129,00	149,00	164,00	179,00
137,00	147,00	154,00	162,00

100 Stk. pcs.	50 Stk. pcs.	20 Stk. pcs.	1 Stk. pc.
121,00	131,00	136,00	141,00
134,00	154,00	169,00	184,00
-	-	-	174,00

Art.-Nr.: Art. No.:					
07870	Duschtürbeschlag, G-G 135° Beidseitig öffnend Für 8 & 10 mm ESG Shower door hinge, g-g 135° Double action For 8 & 10 mm tempered glass	07490	Winkelverbinder, G-W 90° Mit Langlochanschraubplatte Für 8 – 12 mm ESG Connector, g-w 90° With slotted hole screw plate For 8 – 12 mm tempered glass	07493	Winkelverbinder, G-G 90° Für 8 – 12 mm ESG Connector, g-g 90° For 8 – 12 mm tempered glass



€ Stückpreis Price per piece	100 Stk. pcs.	50 Stk. pcs.	20 Stk. pcs.	1 Stk. pc.
31	121,00	131,00	136,00	138,00
55 ¹⁾	134,00	154,00	169,00	179,00
65	-	-	-	171,00

100 Stk. pcs.	50 Stk. pcs.	20 Stk. pcs.	1 Stk. pc.
59,00	64,00	67,00	69,00
68,00	74,00	79,00	83,00
67,00	73,00	78,00	82,00

100 Stk. pcs.	50 Stk. pcs.	20 Stk. pcs.	1 Stk. pc.
64,00	69,00	72,00	74,00
74,00	80,00	84,00	89,00
71,00	77,00	82,00	86,00

MILANO ORIGINAL

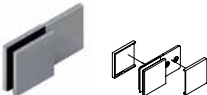
PENDELTÜRSYSTEM
DOUBLE ACTION DOOR SYSTEM

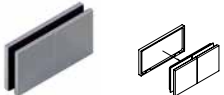
Art.-Nr.: Art. No.:	 07497	 07498	 07499
	<p>Längsverbinder, G-W 180° Für 8 – 12 mm ESG</p> <p>Connector, g-w 180° For 8 – 12 mm tempered glass</p>	<p>Längsverbinder, G-W 180° Für 8 – 12 mm ESG</p> <p>Connector, g-w 180° For 8 – 12 mm tempered glass</p>	<p>Längsverbinder, G-G 180° Für 8 – 12 mm ESG</p> <p>Connector, g-g 180° For 8 – 12 mm tempered glass</p>
<p>€ Stückpreis Price per piece</p>	<p>1 Stk. pc.</p>	<p>1 Stk. pc.</p>	<p>1 Stk. pc.</p>
<p>31</p>	<p>79,00</p>	<p>75,00</p>	<p>81,00</p>
<p>55</p>	<p>93,00</p>	<p>88,00</p>	<p>93,00</p>





FUNKTIONEN
FEATURES

Einstellbare Nulllage
3-Punkt-Nulllage
Vollabgedeckte Verschraubung
Basismaterial: Messing

Adjustable index position
3-point index position
Covered screws
Base material: Brass

DEM NÄCHST
LIEFERBAR

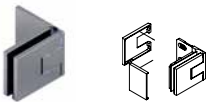
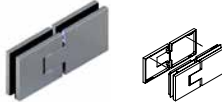
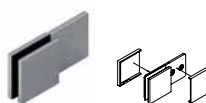

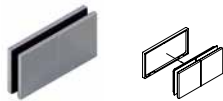
AVAILABLE
SOON

<p>Art.-Nr.: Art. No.:</p>	<p>96312</p> 	<p>96330</p> 	<p>07490</p> 	
<p>Duschtürbeschlag, G-W 90° Mit Langlochanschraubplatte Beidseitig öffnend Für 8 & 10 mm ESG</p> <p>Shower door hinge, g-w 90° With slotted hole screw plate Double action For 8 & 10 mm tempered glass</p>	<p>Duschtürbeschlag, G-G 180° Beidseitig öffnend Für 8 & 10 mm ESG</p> <p>Shower door hinge, g-g 180° Double action For 8 & 10 mm tempered glass</p>	<p>Winkelverbinder, G-W 90° Mit Langlochanschraubplatte Für 8 – 12 mm ESG</p> <p>Connector, g-w 90° With slotted hole screw plate For 8 – 12 mm tempered glass</p>		
<p>€ Stückpreis Price per piece</p>	<p>100 Stk. pcs.</p>	<p>50 Stk. pcs.</p>	<p>20 Stk. pcs.</p>	<p>1 Stk. pc.</p>
<p>31</p>	99,00	109,65	122,55	129,00
<p>55</p>	125,00	135,00	149,00	159,00
<p>Art.-Nr.: Art. No.:</p>	<p>07493</p> 	<p>07497</p> 	<p>07498</p> 	
<p>Winkelverbinder, G-G 90° Für 8 – 12 mm ESG</p> <p>Connector, g-g 90° For 8 – 12 mm tempered glass</p>	<p>Längsverbinder, G-W 180° Für 8 – 12 mm ESG</p> <p>Connector, g-w 180° For 8 – 12 mm tempered glass</p>	<p>Längsverbinder, G-W 180° Für 8 – 12 mm ESG</p> <p>Connector, g-w 180° For 8 – 12 mm tempered glass</p>		
<p>€ Stückpreis Price per piece</p>	<p>100 Stk. pcs.</p>	<p>50 Stk. pcs.</p>	<p>20 Stk. pcs.</p>	<p>1 Stk. pc.</p>
<p>31</p>	64,00	69,00	72,00	74,00
<p>55</p>	74,00	80,00	84,00	89,00
<p>Art.-Nr.: Art. No.:</p>	<p>07499</p> 	<p>€ Stückpreis Price per piece</p>	<p>1 Stk. pc.</p>	
<p>Längsverbinder, G-G 180° Für 8 – 12 mm ESG</p> <p>Connector, g-g 180° For 8 – 12 mm tempered glass</p>	<p>31</p>	81,00		
	<p>55</p>	93,00		

FUNKTIONEN
FEATURES



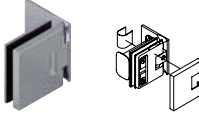
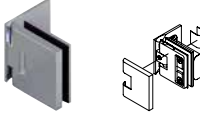
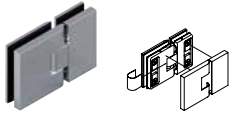

Einstellbare Nulllage
Ca. 5 mm Hebe-Senk-Mechanismus
In das Band integrierte Dichtung
Vollabgedeckte Verschraubung
Basismaterial: Messing

Adjustable index position
Approx. 5 mm gravity based lifting hinge
Integrated seal in hinge
Covered backplate
Base material: Brass

Art.-Nr.: Art. No.:												
82412	Duschtürbeschlag, G-W 90°, DIN-rechts Abdeckung der Wandanschraubplatte aus hochwertigem Edelstahl Beidseitig öffnend, Für 8 & 10 mm ESG Shower door hinge, g-w 90°, EN-right Stainless steel covered wall mounting plate Double action For 8 & 10 mm tempered glass	82413	Duschtürbeschlag, G-W 90°, DIN-links Abdeckung der Wandanschraubplatte aus hochwertigem Edelstahl Beidseitig öffnend, Für 8 & 10 mm ESG Shower door hinge, g-w 90°, EN-left Stainless steel covered wall mounting plate Double action For 8 & 10 mm tempered glass									
82430	Duschtürbeschlag, G-G 180°, DIN-rechts Beidseitig öffnend Für 8 & 10 mm ESG Shower door hinge, g-g 180°, EN-right Double action For 8 & 10 mm tempered glass											
€ Stückpreis Price per piece	100 Stk. pcs.	50 Stk. pcs.	20 Stk. pcs.	1 Stk. pc.	100 Stk. pcs.	50 Stk. pcs.	20 Stk. pcs.	1 Stk. pc.	100 Stk. pcs.	50 Stk. pcs.	20 Stk. pcs.	1 Stk. pc.
	116,18	127,80	134,90	142,00	116,18	127,80	134,90	142,00	151,36	166,50	175,75	185,00
	130,09	143,10	151,05	159,00	130,09	143,10	151,05	159,00	185,73	204,30	215,65	227,00

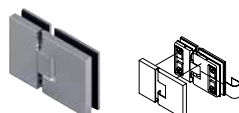
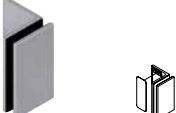
DEMNÄCHST
LIEFERBAR
AVAILABLE
SOON

DEMNÄCHST
LIEFERBAR
AVAILABLE
SOON

Art.-Nr.: Art. No.:												
82431	Duschtürbeschlag, G-G 180°, DIN-links Beidseitig öffnend Für 8 & 10 mm ESG Shower door hinge, g-g 180°, EN-left Double action For 8 & 10 mm tempered glass	94482	Winkelverbinder, G-W 90° Abdeckung der Langlochanschraubplatte aus hochwertigem Edelstahl Für 8 mm ESG Connector, g-w 90° With slotted hole screw plate with stainless steel cover For 8 mm tempered glass									
94483	Winkelverbinder, G-G 90° Für 8 mm ESG Connector, g-g 90° For 8 mm tempered glass											
€ Stückpreis Price per piece	100 Stk. pcs.	50 Stk. pcs.	20 Stk. pcs.	1 Stk. pc.	100 Stk. pcs.	50 Stk. pcs.	20 Stk. pcs.	1 Stk. pc.	100 Stk. pcs.	50 Stk. pcs.	20 Stk. pcs.	1 Stk. pc.
	151,36	166,50	175,75	185,00	29,00	35,00	39,00	41,00	36,00	39,00	43,00	45,00
	185,73	204,30	215,65	227,00	-	-	-	-	-	-	-	-

FUNKTIONEN
FEATURES

Einstellbare Nulllage
Flächenbündige Verschraubung
Ca. 5 mm Hebe-Senk-Mechanismus
In das Band integrierte Dichtung
Basismaterial: Messing

Adjustable index position
Countersunk screws
Approx. 5 mm gravity based lifting hinge
Integrated seal in hinge
Base material: Brass

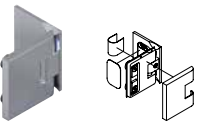
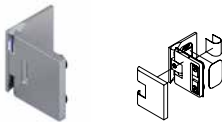
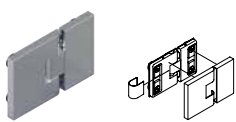
Art.-Nr.: Art. No.:	81412				81413				81430			
	100 Stk. pcs.	50 Stk. pcs.	20 Stk. pcs.	1 Stk. pc.	100 Stk. pcs.	50 Stk. pcs.	20 Stk. pcs.	1 Stk. pc.	100 Stk. pcs.	50 Stk. pcs.	20 Stk. pcs.	1 Stk. pc.
	 <p>Duschtürbeschlag, G-W 90°, DIN-rechts Abdeckung der Wandanschraubplatte aus hochwertigem Edelstahl Beidseitig öffnend, Für 8 & 10 mm ESG</p> <p>Shower door hinge, g-w 90°, EN-right With slotted hole screw plate with stainless steel cover, Double action For 8 & 10 mm tempered glass</p>				 <p>Duschtürbeschlag, G-W 90°, DIN-links Abdeckung der Wandanschraubplatte aus hochwertigem Edelstahl Beidseitig öffnend, Für 8 & 10 mm ESG</p> <p>Shower door hinge, g-w 90°, EN-left With slotted hole screw plate with stainless steel cover, Double action For 8 & 10 mm tempered glass</p>				 <p>Duschtürbeschlag, G-G 180°, DIN-rechts Beidseitig öffnend Für 8 & 10 mm ESG</p> <p>Shower door hinge, g-g 180°, EN-right Double action For 8 & 10 mm tempered glass</p>			
€ Stückpreis Price per piece	31	55			31	55			31	55		
	105,55	116,10	122,55	129,00	105,55	116,10	122,55	129,00	140,73	154,80	163,40	172,00
	113,73	125,10	132,05	139,00	113,73	125,10	132,05	139,00	171,00	188,10	198,55	209,00

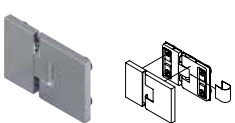
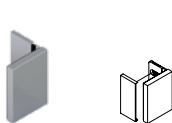
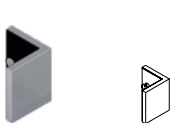
Art.-Nr.: Art. No.:	81431				81491				81492			
	100 Stk. pcs.	50 Stk. pcs.	20 Stk. pcs.	1 Stk. pc.	100 Stk. pcs.	50 Stk. pcs.	20 Stk. pcs.	1 Stk. pc.	100 Stk. pcs.	50 Stk. pcs.	20 Stk. pcs.	1 Stk. pc.
	 <p>Duschtürbeschlag, G-G 180°, DIN-links Beidseitig öffnend Für 8 und 10 mm ESG</p> <p>Shower door hinge, g-g 180°, EN-left Double action For 8 & 10 mm tempered glass</p>				 <p>Winkelverbinder, G-W 90° Für 8 & 10 mm ESG</p> <p>Connector, g-w 90° For 8 & 10 mm tempered glass</p>				 <p>Winkelverbinder, G-G 90° Für 8 & 10 mm ESG</p> <p>Connector, g-g 90° For 8 & 10 mm tempered glass</p>			
€ Stückpreis Price per piece	31	55			31	55			31	55		
	140,73	154,80	163,40	172,00	55,64	61,20	64,60	68,00	59,73	65,70	69,35	73,00
	171,00	188,10	198,55	209,00	72,82	80,10	84,55	89,00	79,36	87,30	92,15	97,00

Notwendiges Montagewerkzeug (Art.-Nr. 81499) finden Sie auf Seite 44

You will find the required assembly tool (art. no.: 81499) on page 44

FUNKTIONEN
FEATURES

Stufenlos einstellbare Nulllage
Basismaterial: Messing

Adjustable index position
Base material: Brass

DEMNÄCHST
LIEFERBAR

AVAILABLE
SOON



Art.-Nr. Art. No.:	94425				94430			
	<p>Duschtürbeschlag, G-W 90° Mit Langlochschraubplatte mit Abdeckung aus hochwertigem Edelstahl Für 8 mm ESG</p> <p>Shower door hinge, g-w 90° With slotted hole screw plate with stainless steel cover For 8 mm tempered glass</p>				<p>Duschtürbeschlag, G-G 180° Für 8 mm ESG</p> <p>Shower door hinge, g-g 180° For 8 mm tempered glass</p>			
€ Stückpreis Price per piece	100 Stk. pcs.	50 Stk. pcs.	20 Stk. pcs.	1 Stk. pc.	100 Stk. pcs.	50 Stk. pcs.	20 Stk. pcs.	1 Stk. pc.
31	49,00	55,00	59,00	62,00	59,00	68,00	77,00	85,00

Art.-Nr. Art. No.:	94482				94483			
	<p>Winkelverbinder, G-W 90° Mit Langlochschraubplatte mit Abdeckung aus hochwertigem Edelstahl Für 8 mm ESG</p> <p>Connector, g-w 90° With slotted hole screw plate with stainless steel cover For 8 mm tempered glass</p>				<p>Winkelverbinder, G-G 90° Für 8 mm ESG</p> <p>Connector, g-g 90° For 8 mm tempered glass</p>			
€ Stückpreis Price per piece	100 Stk. pcs.	50 Stk. pcs.	20 Stk. pcs.	1 Stk. pc.	100 Stk. pcs.	50 Stk. pcs.	20 Stk. pcs.	1 Stk. pc.
31	29,00	35,00	39,00	41,00	36,00	39,00	43,00	45,00



KL MEGLA ZUBEHÖR ACCESSORIES







Qualität und Sicherheit sind Prämissen, die sich durch unser komplettes Produktportfolio ziehen. Denn auch vermeintliche Kleinigkeiten können über die Stabilität und Haltbarkeit einer Glastüranlage entscheiden. Wir fertigen unser Zubehör passend zu unseren Beschlägen an und setzen auch bei unseren Stabilisationsstangen und Griffen auf hochwertiges Messing und Edelstahl. Bei unseren Dichtprofilen haben Sie die Wahl zwischen Klebe-, Aufsteck- und Magnetdichtprofilen.

Ensuring quality and safety is a major point in our product through our complete product portfolio. Because even little things can influence the stability and durability of a glass door system. We manufacture our accessories to match our fittings and also use high-quality brass and stainless steel for our stabilizing bars and handles. With our sealing profiles you have the choice between adhesive, plug-on and magnetic sealing profiles.

FUNKTIONEN
FEATURES

Stabilisierungsstangen & Handtuchhalter
Basismaterial: Messing

Support Bars & Towel Bars
Base material: Brass

Art.-Nr.: Art. No.:																																																																										
67070	<p>Stabilisierungsstange für Deckenmontage G-D, Rohrlänge max. 500 mm Für 8 mm ESG Inkl. Zuschnitt</p> <p>Support bar for ceiling installation g-c, Bar length max. 500 mm For 8 mm tempered glass Incl. cutting</p>	<p>Stabilisierungsstange, G-W 45° Rohrlänge 1000 mm Rechte & linke Scheibe Für 8 mm ESG</p> <p>Support bar, g-w 45° Bar length 1000 mm Right & left panel For 8 mm tempered glass</p>	<p>Stabilisierungsstange, G-W 90° Rohrlänge 1000 mm Für 8 mm ESG</p> <p>Support bar, g-w 90° Bar length 1000 mm For 8 mm tempered glass</p>																																																																							
<table border="1"> <thead> <tr> <th>€ Stückpreis Price per piece</th> <th>1 Stk. pc.</th> <th>100 Stk. pcs.</th> <th>50 Stk. pcs.</th> <th>20 Stk. pcs.</th> <th>1 Stk. pc.</th> </tr> </thead> <tbody> <tr> <td>31</td> <td>139,00</td> <td>52,25</td> <td>72,60</td> <td>84,70</td> <td>110,00</td> </tr> <tr> <td>46</td> <td>-</td> <td>-</td> <td>-</td> <td>-</td> <td>117,00</td> </tr> <tr> <td>55</td> <td>-</td> <td>58,90</td> <td>81,84</td> <td>95,48</td> <td>124,00</td> </tr> </tbody> </table>	€ Stückpreis Price per piece	1 Stk. pc.	100 Stk. pcs.	50 Stk. pcs.	20 Stk. pcs.	1 Stk. pc.	31	139,00	52,25	72,60	84,70	110,00	46	-	-	-	-	117,00	55	-	58,90	81,84	95,48	124,00	<table border="1"> <thead> <tr> <th>€ Stückpreis Price per piece</th> <th>1 Stk. pc.</th> <th>100 Stk. pcs.</th> <th>50 Stk. pcs.</th> <th>20 Stk. pcs.</th> <th>1 Stk. pc.</th> </tr> </thead> <tbody> <tr> <td>31</td> <td>139,00</td> <td>52,25</td> <td>72,60</td> <td>84,70</td> <td>110,00</td> </tr> <tr> <td>46</td> <td>-</td> <td>-</td> <td>-</td> <td>-</td> <td>117,00</td> </tr> <tr> <td>55</td> <td>-</td> <td>58,90</td> <td>81,84</td> <td>95,48</td> <td>124,00</td> </tr> </tbody> </table>	€ Stückpreis Price per piece	1 Stk. pc.	100 Stk. pcs.	50 Stk. pcs.	20 Stk. pcs.	1 Stk. pc.	31	139,00	52,25	72,60	84,70	110,00	46	-	-	-	-	117,00	55	-	58,90	81,84	95,48	124,00	<table border="1"> <thead> <tr> <th>€ Stückpreis Price per piece</th> <th>1 Stk. pc.</th> <th>100 Stk. pcs.</th> <th>50 Stk. pcs.</th> <th>20 Stk. pcs.</th> <th>1 Stk. pc.</th> </tr> </thead> <tbody> <tr> <td>31</td> <td>139,00</td> <td>42,75</td> <td>59,40</td> <td>69,30</td> <td>90,00</td> </tr> <tr> <td>46</td> <td>-</td> <td>-</td> <td>-</td> <td>-</td> <td>92,00</td> </tr> <tr> <td>55</td> <td>-</td> <td>47,98</td> <td>66,66</td> <td>77,77</td> <td>101,00</td> </tr> </tbody> </table>	€ Stückpreis Price per piece	1 Stk. pc.	100 Stk. pcs.	50 Stk. pcs.	20 Stk. pcs.	1 Stk. pc.	31	139,00	42,75	59,40	69,30	90,00	46	-	-	-	-	92,00	55	-	47,98	66,66	77,77	101,00
€ Stückpreis Price per piece	1 Stk. pc.	100 Stk. pcs.	50 Stk. pcs.	20 Stk. pcs.	1 Stk. pc.																																																																					
31	139,00	52,25	72,60	84,70	110,00																																																																					
46	-	-	-	-	117,00																																																																					
55	-	58,90	81,84	95,48	124,00																																																																					
€ Stückpreis Price per piece	1 Stk. pc.	100 Stk. pcs.	50 Stk. pcs.	20 Stk. pcs.	1 Stk. pc.																																																																					
31	139,00	52,25	72,60	84,70	110,00																																																																					
46	-	-	-	-	117,00																																																																					
55	-	58,90	81,84	95,48	124,00																																																																					
€ Stückpreis Price per piece	1 Stk. pc.	100 Stk. pcs.	50 Stk. pcs.	20 Stk. pcs.	1 Stk. pc.																																																																					
31	139,00	42,75	59,40	69,30	90,00																																																																					
46	-	-	-	-	92,00																																																																					
55	-	47,98	66,66	77,77	101,00																																																																					
67085		67087		67088																																																																						
<p>Stabilisierungsstange, G-W 90° Rohrlänge 1500 mm Für 8 mm ESG</p> <p>Support bar, g-w 90° Bar length 1500 mm For 8 mm tempered glass</p>	<p>Stabilisierungsstange, G-W 90° Bohrung im Glas Rohrlänge 1000 mm Für 8 mm ESG</p> <p>Support bar, g-w 90° Drill hole in glass Bar length 1000 mm For 8 mm tempered glass</p>	<p>Stabilisierungsstange, G-W 90° Bohrung im Glas Rohrlänge 1500 mm Für 8 mm ESG</p> <p>Support bar, g-w 90° Drill hole in glass Bar length 1500 mm For 8 mm tempered glass</p>																																																																								
<table border="1"> <thead> <tr> <th>€ Stückpreis Price per piece</th> <th>1 Stk. pc.</th> <th>100 Stk. pcs.</th> <th>50 Stk. pcs.</th> <th>20 Stk. pcs.</th> <th>1 Stk. pc.</th> </tr> </thead> <tbody> <tr> <td>31</td> <td>106,00</td> <td>55,10</td> <td>76,56</td> <td>89,32</td> <td>116,00</td> </tr> <tr> <td>46</td> <td>108,00</td> <td>-</td> <td>-</td> <td>-</td> <td>118,00</td> </tr> <tr> <td>55</td> <td>117,00</td> <td>60,33</td> <td>83,82</td> <td>97,79</td> <td>127,00</td> </tr> </tbody> </table>	€ Stückpreis Price per piece	1 Stk. pc.	100 Stk. pcs.	50 Stk. pcs.	20 Stk. pcs.	1 Stk. pc.	31	106,00	55,10	76,56	89,32	116,00	46	108,00	-	-	-	118,00	55	117,00	60,33	83,82	97,79	127,00	<table border="1"> <thead> <tr> <th>€ Stückpreis Price per piece</th> <th>1 Stk. pc.</th> <th>100 Stk. pcs.</th> <th>50 Stk. pcs.</th> <th>20 Stk. pcs.</th> <th>1 Stk. pc.</th> </tr> </thead> <tbody> <tr> <td>31</td> <td>106,00</td> <td>55,10</td> <td>76,56</td> <td>89,32</td> <td>116,00</td> </tr> <tr> <td>46</td> <td>108,00</td> <td>-</td> <td>-</td> <td>-</td> <td>118,00</td> </tr> <tr> <td>55</td> <td>117,00</td> <td>60,33</td> <td>83,82</td> <td>97,79</td> <td>127,00</td> </tr> </tbody> </table>	€ Stückpreis Price per piece	1 Stk. pc.	100 Stk. pcs.	50 Stk. pcs.	20 Stk. pcs.	1 Stk. pc.	31	106,00	55,10	76,56	89,32	116,00	46	108,00	-	-	-	118,00	55	117,00	60,33	83,82	97,79	127,00	<table border="1"> <thead> <tr> <th>€ Stückpreis Price per piece</th> <th>1 Stk. pc.</th> </tr> </thead> <tbody> <tr> <td>31</td> <td>132,00</td> </tr> <tr> <td>46</td> <td>134,00</td> </tr> <tr> <td>55</td> <td>143,00</td> </tr> </tbody> </table>	€ Stückpreis Price per piece	1 Stk. pc.	31	132,00	46	134,00	55	143,00																
€ Stückpreis Price per piece	1 Stk. pc.	100 Stk. pcs.	50 Stk. pcs.	20 Stk. pcs.	1 Stk. pc.																																																																					
31	106,00	55,10	76,56	89,32	116,00																																																																					
46	108,00	-	-	-	118,00																																																																					
55	117,00	60,33	83,82	97,79	127,00																																																																					
€ Stückpreis Price per piece	1 Stk. pc.	100 Stk. pcs.	50 Stk. pcs.	20 Stk. pcs.	1 Stk. pc.																																																																					
31	106,00	55,10	76,56	89,32	116,00																																																																					
46	108,00	-	-	-	118,00																																																																					
55	117,00	60,33	83,82	97,79	127,00																																																																					
€ Stückpreis Price per piece	1 Stk. pc.																																																																									
31	132,00																																																																									
46	134,00																																																																									
55	143,00																																																																									

Art.-Nr.: Art. No.:		67090	Art.-Nr.: Art. No.:		67095	Art.-Nr.: Art. No.:		67096
Stabilisationsstange, G-G Rohrlänge 1000 mm Für 8 mm ESG Support bar, g-g Bar length 1000 mm For 8 mm tempered glass			Stabilisationsstange, G-G Rohrlänge 1500 mm Für 8 mm ESG Support bar, g-g Bar length 1500 mm For 8 mm tempered glass			T-Stück mit 90° Glasaufnahme Verschiebbar, Für 67080 bis 67095 Rohrlänge 100 mm Für 8 mm ESG T-unit with 90° glass adapter Moveable, For 67080 till 67095 Bar length 100 mm For 8 mm tempered glass		

€ Stückpreis Price per piece	100 Stk. pcs.	50 Stk. pcs.	20 Stk. pcs.	1 Stk. pc.
31	56,53	78,54	91,63	119,00
46	-	-	-	121,00
55	61,75	85,80	100,10	130,00

1 Stk. pc.
125,00
127,00
137,00

100 Stk. pcs.	50 Stk. pcs.	20 Stk. pcs.	1 Stk. pc.
40,38	56,10	65,45	85,00
-	-	-	111,00
57,00	79,20	92,40	120,00

Art.-Nr.: Art. No.:		06706	Art.-Nr.: Art. No.:		06709	Art.-Nr.: Art. No.:		06710
Handtuchhalter, G-G Rohrlänge 1000 mm Für 8 mm ESG Towel bar, g-g Bar length 1000 mm For 8 mm tempered glass			Handtuchhalter, G-G, Rohrlänge 1000 mm Mit Griff Für 8 mm ESG Towel bar, g-g, Bar length 1000 mm With door knob For 8 mm tempered glass			Handtuchhalter Flächenbündige Verschraubung Rohrlänge 1000 mm, Für 8 mm ESG Towel bar Flush screw, Bar length 1000 mm For 8 mm tempered glass		

€ Stückpreis Price per piece	1 Stk. pc.
31	142,00
46	144,00
55	154,00

100 Stk. pcs.	50 Stk. pcs.	20 Stk. pcs.	1 Stk. pc.
74,58	103,62	120,89	157,00
-	-	-	159,00
80,28	111,54	130,13	169,00

1 Stk. pc.
161,00
-
-

FILIGRANO

ZUBEHÖR
ACCESSORIES





FUNKTIONEN
FEATURES



Stabilisierungsstangen & Handtuchhalter
Eckiges Design
Basismaterial: Messing / Edelstahl

Support Bars & Towel Bars
Square design
Base material: Brass / Stainless steel





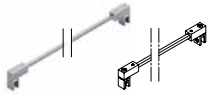
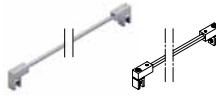

³⁾ Vierkantstab aus hochwertigem Edelstahl matt gebürstet (OF 91)

³⁾ Square bar is made of brushed stainless steel (finish 91)

Art.-Nr.: Art. No.:			
67160	Stabilisierungsstange, G-W Verstellbar +/- 90°, Stablänge 1050 mm Eckige Form Für 6 – 8 mm ESG Support bar, g-w Adjustable +/- 90°, Bar length 1050 mm Square design For 6 – 8 mm tempered glass	67161	67180
€ Stückpreis Price per piece	1 Stk. pc.	1 Stk. pc.	1 Stk. pc.
	131,00	131,00	167,00
 ³⁾	146,00	146,00	187,00





Art.-Nr.: Art. No.:			
67181	Stabilisierungsstange, G-W Verstellbar +/- 90°, Stablänge 1500 mm Eckige Form Für 10 – 12 mm ESG Support bar, g-w Adjustable +/- 90°, Bar length 1500 mm Square design For 10 – 12 mm tempered glass	67162	67163
€ Stückpreis Price per piece	1 Stk. pc.	1 Stk. pc.	1 Stk. pc.
	167,00	158,00	158,00
 ³⁾	187,00	175,00	175,00

FILIGRANO

Art.-Nr.: Art. No.:			
67182	67183	67166	
<p>Stabilisationsstange, G-G Verstellbar 0 – 360°, Stablänge 1500 mm Eckige Form Für 6 – 8 mm ESG</p> <p>Support bar, g-g Adjustable 0 – 360°, Bar length 1500 mm Square design For 6 – 8 mm tempered glass</p>	<p>Stabilisationsstange, G-G Verstellbar 0 – 360°, Stablänge 1050 mm Eckige Form Für 10 – 12 mm ESG</p> <p>Support bar, g-g Adjustable 0 – 360°, Bar length 1050 mm Square design For 10 – 12 mm tempered glass</p>	<p>T-Stück für Stabilisationsstange Eckige Form Für 6 – 8 mm ESG</p> <p>T-unit for support bar Square design For 6 – 8 mm tempered glass</p>	
<p>€ Stückpreis Price per piece</p>	<p>1 Stk. pc.</p>	<p>1 Stk. pc.</p>	<p>1 Stk. pc.</p>
	194,00	194,00	79,00
 ³⁾	217,00	217,00	92,00
67167	67266	67267	
<p>T-Stück für Stabilisationsstange Eckige Form Für 10 – 12 mm ESG</p> <p>T-unit for support bar Square design For 10 – 12 mm tempered glass</p>	<p>T-Stück für Stabilisationsstange Eckige Form Für 6 – 8 mm ESG</p> <p>T-unit for support bar Square design For 6 – 8 mm tempered glass</p>	<p>T-Stück für Stabilisationsstange Eckige Form Für 10 – 12 mm ESG</p> <p>T-unit for support bar Square design For 10 – 12 mm tempered glass</p>	
<p>€ Stückpreis Price per piece</p>	<p>1 Stk. pc.</p>	<p>1 Stk. pc.</p>	<p>1 Stk. pc.</p>
	79,00	89,00	89,00
 ³⁾	92,00	102,00	102,00

FILIGRANO

ZUBEHÖR
ACCESSORIES

Art.-Nr. Art. No.:		
06730	Handtuchhalter, G-G Stablänge 1000 mm Eckige Form Für 8 mm ESG Towel bar, g-g Bar length 1000 mm Square design For 8 mm tempered glass	06731
€ Stückpreis Price per piece	1 Stk. pc.	1 Stk. pc.
	142,00	162,00
 ³⁾	159,00	179,00









FILIGRANO

FUNKTIONEN
FEATURES

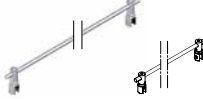

Stabilisationsstangen & Handtuchhalter
Rundes Design
Basismaterial: Messing / Edelstahl

Support Bars & Towel Bars
Round design
Base material: Brass / Stainless steel

<p>Art.-Nr.: Art. No.:</p>	<p>67110</p> 	<p>67112</p> 	<p>67120</p> 
	<p>Stabilisationsstange, G-W Stablänge 1050 mm Runde Form Für 8 mm ESG</p> <p>Support bar, g-w Bar length 1050 mm Round design For 8 mm tempered glass</p>	<p>Stabilisationsstange, G-W Stablänge 1500 mm Runde Form Für 8 mm ESG</p> <p>Support bar, g-w Bar length 1500 mm Round design For 8 mm tempered glass</p>	<p>Stabilisationsstange, G-G Stablänge 1050 mm Runde Form Für 8 mm ESG</p> <p>Support bar, g-g Bar length 1050 mm Round design For 8 mm tempered glass</p>
<p>€ Stückpreis Price per piece</p>	<p>1 Stk. pc.</p>	<p>1 Stk. pc.</p>	<p>1 Stk. pc.</p>
<p>31</p>	<p>112,00</p>	<p>132,00</p>	<p>136,00</p>
<p>Art.-Nr.: Art. No.:</p>	<p>67122</p> 	<p>67130</p> 	<p>67132</p> 
	<p>Stabilisationsstange, G-G Stablänge 1500 mm Runde Form Für 8 mm ESG</p> <p>Support bar, g-g Bar length 1500 mm Round design For 8 mm tempered glass</p>	<p>Stabilisationsstange, G-W 45° Stablänge 1050 mm Runde Form Für 8 mm ESG</p> <p>Support bar, g-w 45° Bar length 1050 mm Round design For 8 mm tempered glass</p>	<p>Stabilisationsstange, G-W 45° Stablänge 1500 mm Runde Form Für 8 mm ESG</p> <p>Support bar, g-w 45° Bar length 1500 mm Round design For 8 mm tempered glass</p>
<p>€ Stückpreis Price per piece</p>	<p>1 Stk. pc.</p>	<p>1 Stk. pc.</p>	<p>1 Stk. pc.</p>
<p>31</p>	<p>156,00</p>	<p>144,00</p>	<p>164,00</p>

FILIGRANO



ZUBEHÖR
ACCESSORIES



<p>Art.-Nr.: Art. No.:</p>	<p>06740</p> 	<p>06741</p> 
	<p>Handtuchhalter, G-G Stablänge 1000 mm Runde Form Für 8 mm ESG</p> <p>Towel bar, g-g Bar length 1000 mm Round design For 8 mm tempered glass</p>	<p>Handtuchhalter, G-G Stablänge 1000 mm, mit Griff Runde Form Für 8 mm ESG</p> <p>Towel bar, g-g Bar length 1000 mm With door knob Round design For 8 mm tempered glass</p>
<p>€ Stückpreis Price per piece</p>	<p>1 Stk. pc.</p>	<p>1 Stk. pc.</p>
<p>31</p>	<p>142,00</p>	<p>150,00</p>



TÜRGRIFFE

DOOR HANDLES

Art.-Nr.: Art. No.:						
80401	<p>ø 32 mm, beidseitig Für 8 mm ESG Basismaterial: Messing</p> <p>ø 32 mm, double-sided For 8 mm tempered glass Base material: Brass</p>	05003	<p>ø 32 mm, beidseitig Für 6 – 12 mm ESG Basismaterial: Messing</p> <p>ø 32 mm, double-sided For 6 – 12 mm tempered glass Base material: Brass</p>	05007	<p>ø 35 mm, beidseitig Für 6 – 12 mm ESG Basismaterial: Messing</p> <p>ø 35 mm, double-sided For 6 – 12 mm tempered glass Base material: Brass</p>	
€ Stückpreis Price per piece	1 Stk. pc.	1 Stk. pc.	100 Stk. pcs.	50 Stk. pcs.	20 Stk. pcs.	1 Stk. pc.
31	13,00	42,00	16,00	18,00	21,00	31,00
46	-	43,00	-	-	-	-
55	-	48,00	23,00	27,00	29,00	38,00

Art.-Nr.: Art. No.:					
05013	<p>ø 35 mm, beidseitig Mit Puffer einseitig auf der flachen Seite Für 6 – 12 mm ESG Basismaterial: Messing</p> <p>ø 35 mm, double-sided With buffer on the flat side For 6 – 12 mm tempered glass Base material: Brass</p>	05014	<p>ø 35 mm, beidseitig Mit Puffer beidseitig Für 6 – 12 mm ESG Basismaterial: Messing</p> <p>ø 35 mm, double-sided With buffer on both sides For 6 – 12 mm tempered glass Base material: Brass</p>	05015	<p>ø 35 mm, beidseitig Mit Puffer beidseitig Für 6 – 12 mm ESG Basismaterial: Messing</p> <p>ø 35 mm, double-sided With buffer on both sides For 6 – 12 mm tempered glass Base material: Brass</p>
€ Stückpreis Price per piece	1 Stk. pc.	1 Stk. pc.	1 Stk. pc.		
31	48,00	55,00	61,00		
46	-	-	-		
55	-	-	-		

TÜRGRIFFE

DOOR HANDLES

ZUBEHÖR
ACCESSORIES

Art.-Nr.: Art. No.:	05030 	05032 
	<p>30 x 30 x 30 mm, beidseitig Eckige Form Für 6 – 12 mm ESG Basismaterial: Messing</p> <p>30 x 30 x 30 mm, double-sided Square design For 6 – 12 mm tempered glass Base material: Brass</p>	<p>30 x 30 x 30 mm, beidseitig Mit Puffer einseitig Für 6 – 12 mm ESG Basismaterial: Messing</p> <p>30 x 30 x 30 mm, double-sided With buffer on one side For 6 – 12 mm tempered glass Base material: Brass</p>



€ Stückpreis Price per piece	100 Stk. pcs.	50 Stk. pcs.	20 Stk. pcs.	1 Stk. pc.	1 Stk. pc.
31	-	-	-	48,00	59,00
46	-	-	-	51,00	60,00
55	-	-	-	55,00	66,00
65	55,00	60,00	64,00	68,00	-





DICHTPROFILE

SEALS

KLEBEDICHTPROFILE SELF-ADHESIVE SEALS

Art.-Nr.: Art. No.:				
69230	69231	69240		
<p>Streifdichtung zum Aufkleben Länge 2500 mm Für 8 – 12 mm Glas Lagerzeit max. 6 Monate</p> <p>Bulb seal, self-adhesive Length 2500 mm For 8 – 12 mm glass Can be stored for up to 6 months</p>	<p>Streifdichtung zum Aufkleben Länge 6000 mm Für 8 – 12 mm Glas Lagerzeit max. 6 Monate</p> <p>Bulb seal, self-adhesive Length 6000 mm For 8 – 12 mm glass Can be stored for up to 6 months</p>	<p>Streifdichtung mit Steg zum Aufkleben Länge 2500 mm Für 8 – 12 mm Glas Lagerzeit max. 6 Monate</p> <p>Bulb seal, self-adhesive with T-channel Length 2500 mm For 8 – 12 mm glass Can be stored for up to 6 months</p>		
<p>€ Stückpreis Price per piece</p>	<p>> 20 Stk. pcs.</p>	<p>1 Stk. pc.</p>	<p>> 20 Stk. pcs.</p>	<p>1 Stk. pc.</p>
weiß white	15,00	21,00	16,00	22,00

MAGNET-KLEBEDICHTPROFILE MAGNETIC SELF-ADHESIVE SEALS

Art.-Nr.: Art. No.:				
79250	79260	79270		
<p>Magnetprofil 90° zum Aufkleben Länge 2500 mm Für 8 – 12 mm Glas Lagerzeit max. 6 Monate</p> <p>Magnetic seal 90°, self-adhesive Length 2500 mm For 8 – 12 mm glass Can be stored for up to 6 months</p>	<p>Magnetprofil 180° zum Aufkleben Länge 2500 mm Für 8 – 12 mm Glas Lagerzeit max. 6 Monate</p> <p>Magnetic seal 180°, self-adhesive Length 2500 mm For 8 – 12 mm glass Can be stored for up to 6 months</p>	<p>Magnetprofil 180° zum Aufkleben Länge 2500 mm Für 8 – 12 mm Glas Lagerzeit max. 6 Monate</p> <p>Magnetic seal 180°, self-adhesive Length 2500 mm For 8 – 12 mm glass Can be stored for up to 6 months</p>		
<p>€ Setpreis Price per set</p>	<p>> 20 Sets</p>	<p>1 Set</p>	<p>> 20 Sets</p>	<p>1 Set</p>
lichtgrau bright grey	34,50	39,50	34,50	39,50

DICHTPROFILE

SEALS

ZUBEHÖR
ACCESSORIES

MAGNET-AUFSTECKDICHTPROFILE MAGNETIC PLUG-ON SEALS

Art.-Nr. Art. No.:								
79000	Magnetprofil 135° Länge 2010 mm Für 6 & 8 mm Glas Magnetic seal 135° Length 2010 mm For 6 & 8 mm glass	79001	Magnetprofil 135° Länge 2500 mm Für 6 & 8 mm Glas Magnetic seal 135° Length 2500 mm For 6 & 8 mm glass	79010	Magnetprofil 90° Länge 2010 mm Für 6 & 8 mm Glas Magnetic seal 90° Length 2010 mm For 6 & 8 mm glass	79011	Magnetprofil 90° Länge 2500 mm Für 6 & 8 mm Glas Magnetic seal 90° Length 2500 mm For 6 & 8 mm glass	
€ Setpreis Price per set	> 20 Sets	1 Set	> 20 Sets	1 Set	> 20 Sets	1 Set	> 20 Sets	1 Set
lichtgrau bright grey	22,50	28,00	28,00	35,00	16,00	20,00	19,00	23,50













Art.-Nr. Art. No.:								
79020	Magnetprofil 180° Länge 2010 mm Für 6 & 8 mm Glas Magnetic seal 180° Length 2010 mm For 6 & 8 mm glass	79021	Magnetprofil 180° Länge 2500 mm Für 6 & 8 mm Glas Magnetic seal 180° Length 2500 mm For 6 & 8 mm glass	79310	Magnetprofil 180° Länge 2010 mm Für 6 & 8 mm Glas Magnetic seal 180° Length 2010 mm For 6 & 8 mm glass	79311	Magnetprofil 180° Länge 2500 mm Für 6 & 8 mm Glas Magnetic seal 180° Length 2500 mm For 6 & 8 mm glass	
€ Setpreis Price per set	> 20 Sets	1 Set	> 20 Sets	1 Set	> 20 Sets	1 Set	> 20 Sets	1 Set
lichtgrau bright grey	16,00	20,00	19,00	23,50	16,00	20,00	19,00	23,50



DICHTPROFILE

SEALS

AUFSTECKDICHTPROFILE PLUG-ON SEALS





Art.-Nr. Art. No.:								
69030	Streifdichtung Länge 2010 mm Für 6 & 8 mm Glas Bulb seal Length 2010 mm For 6 & 8 mm glass	Streifdichtung Länge 2500 mm Für 6 & 8 mm Glas Bulb seal Length 2500 mm For 6 & 8 mm glass	Eckanschlagprofil 90° Länge 2010 mm Für 6 & 8 mm Glas Door jamb seal 90° Length 2010 mm For 6 & 8 mm glass	Eckanschlagprofil 90° Länge 2500 mm Für 6 & 8 mm Glas Door jamb seal 90° Length 2500 mm For 6 & 8 mm glass				
€ Stückpreis Price per piece	> 20 Stk. pcs.	1 Stk. pc.	> 20 Stk. pcs.	1 Stk. pc.				
weiß white	6,00	8,50	8,50	13,00				
12,00	17,00							
69050		69051		69060		69061		
Frontanschlagprofil 180° Länge 2010 mm Für 6 & 8 mm Glas Door jamb seal 180° Length 2010 mm For 6 & 8 mm glass	Frontanschlagprofil 180° Länge 2500 mm Für 6 & 8 mm Glas Door jamb seal 180° Length 2500 mm For 6 & 8 mm glass	Wasserabweisprofil Flexibel, Länge 2010 mm Für 6 & 8 mm Glas Profile Flexible, Length 2010 mm For 6 & 8 mm glass	Wasserabweisprofil Flexibel, Länge 2500 mm Für 6 & 8 mm Glas Profile Flexible, Length 2500 mm For 6 & 8 mm glass					
€ Stückpreis Price per piece	> 20 Stk. pcs.	1 Stk. pc.	> 20 Stk. pcs.	1 Stk. pc.	> 20 Stk. pcs.	1 Stk. pc.		
weiß white	8,50	13,00	12,00	17,00	10,00	14,00	12,00	17,50
69090		69091		69100		69101		
Mitteldichtprofil f. fluchtende Duschtüranordnung, Länge 2010 mm, Für 6 & 8 mm Glas Profile for flush shower door arrangement, Length 2010 mm, For 6 & 8 mm glass	Mitteldichtprofil f. fluchtende Duschtüranordnung, Länge 2500 mm, Für 6 & 8 mm Glas Profile for flush shower door arrangement, Length 2500 mm, For 6 & 8 mm glass	Unteres Wasserabweisprofil mit Lippe 135°, Länge 2010 mm, Für 6 & 8 mm Glas Bottom profile with drip rail lip 135°, Length 2010 mm For 6 & 8 mm glass	Unteres Wasserabweisprofil mit Lippe 135°, Länge 2500 mm, Für 6 & 8 mm Glas Bottom profile with drip rail lip 135°, Length 2500 mm For 6 & 8 mm glass					
€ Stückpreis Price per piece	> 20 Stk. pcs.	1 Stk. pc.	> 20 Stk. pcs.	1 Stk. pc.	> 20 Stk. pcs.	1 Stk. pc.	> 20 Stk. pcs.	1 Stk. pc.
weiß white	7,50	11,50	10,00	14,50	8,00	12,00	14,00	17,00



DICHTPROFILE

SEALS

ZUBEHÖR
ACCESSORIES





AUFSTECKDICHTPROFILE PLUG-ON SEALS



Art.-Nr. Art. No.:								
69105	<p>Wasserabweisprofil mit Lippe fluchtend, Länge 2010 mm Für 6 & 8 mm Glas</p> <p>Profile with drip rail lip Length 2010 mm For 6 & 8 mm glass</p>	<p>Wasserabweisprofil mit Lippe fluchtend, Länge 2500 mm Für 6 & 8 mm Glas</p> <p>Profile with drip rail lip Length 2500 mm For 6 & 8 mm glass</p>	<p>Mitteldichtprofil f. überlappende Duschtüranordnung, Länge 2500 mm, Für 6 & 8 mm Glas</p> <p>Profile for overlapping shower door arrangement, Length 2500 mm, For 6 & 8 mm glass</p>	<p>Mitteldichtprofil f. überlappende Duschtüranordnung, Länge 2500 mm, Für 6 & 8 mm Glas</p> <p>Profile for overlapping shower door arrangement, Length 2500 mm, For 6 & 8 mm glass</p>				
€ Stückpreis Price per piece	>20 Stk. pcs.	1 Stk. pc.	>20 Stk. pcs.	1 Stk. pc.	>20 Stk. pcs.	1 Stk. pc.	>20 Stk. pcs.	1 Stk. pc.
weiß white	11,00	15,00	13,00	20,00	12,00	15,00	14,00	20,00

Art.-Nr. Art. No.:				
69120	<p>Hart-Weich-Lippendichtung Länge 2010 mm Für 6 & 8 mm Glas</p> <p>Bottom wipe Length 2010 mm For 6 & 8 mm glass</p>	<p>Wasserabweisprofil unten mit Streifdichtung, Länge 2010 mm Für 6 & 8 mm Glas</p> <p>Bottom profile with bulb seal Length 2010 mm For 6 & 8 mm glass</p>		
€ Stückpreis Price per piece	>20 Stk. pcs.	1 Stk. pc.	>20 Stk. pcs.	1 Stk. pc.
weiß white	10,00	14,00	9,50	13,00

SCHWALLSCHUTZ

THRESHOLDS

Art.-Nr.: Art. No.:	69070 82 	69070 11 	69080 	69081 
	Schwallschutz Länge 1800 mm Threshold Length 1800 mm	Schwallschutz Länge 1800 mm Threshold Length 1800 mm	Schwallschutz 20 x 10 mm, Länge 1000 mm Threshold 20 x 10 mm, Length 1000 mm	Schwallschutz 20 x 10 mm, Länge 2000 mm Threshold 20 x 10 mm, Length 2000 mm
€ Stückpreis Price per piece	> 20 Stk. pcs.	> 20 Stk. pcs.	> 20 Stk. pcs.	> 20 Stk. pcs.
	1 Stk. pc.	1 Stk. pc.	1 Stk. pc.	1 Stk. pc.
Chromähnlich eloxiert chrome color anodized	-	20,00	-	-
RAL 9010	19,00	-	-	-
Acryl Acrylic	-	-	16,00	31,00
			18,00	33,00





Art.-Nr.: Art. No.:	69130 	69131 
	Schwallschutz 10 x 15 mm, Länge 1000 mm Threshold 10 x 15 mm, 1000 mm	Schwallschutz 10 x 15 mm, Länge 2000 mm Threshold 10 x 15 mm, 2000 mm
€ Stückpreis Price per piece	> 20 Stk. pcs.	> 20 Stk. pcs.
	1 Stk. pc.	1 Stk. pc.
Acryl Acrylic	13,50	20,50
	14,00	22,50

TRÄGERPROFILE & ANSCHLAG





WALL ATTACHMENT BARS & STOPPERS

ZUBEHÖR
ACCESSORIES

TRÄGERPROFILE WALL ATTACHMENT BARS

Art.-Nr.: Art. No.:	69150 16 	69151 16 	69150 82 	69151 82 				
	<p>Trägerprofil für Dichtprofile Länge 2000 mm Für 6 & 8 mm Glas</p> <p>Wall attachment bar for seals Length 2000 mm For 6 & 8 mm glass</p>	<p>Trägerprofil für Dichtprofile Länge 2500 mm Für 6 & 8 mm Glas</p> <p>Wall attachment bar for seals Length 2500 mm For 6 & 8 mm glass</p>	<p>Trägerprofil für Dichtprofile Länge 2000 mm Für 6 & 8 mm Glas</p> <p>Wall attachment bar for seals Length 2000 mm For 6 & 8 mm glass</p>	<p>Trägerprofil für Dichtprofile Länge 2500 mm Für 6 & 8 mm Glas</p> <p>Wall attachment bar for seals Length 2500 mm For 6 & 8 mm glass</p>				
€ Stückpreis Price per piece	> 20 Stk. pcs.	1 Stk. pc.	> 20 Stk. pcs.	1 Stk. pc.	> 20 Stk. pcs.	1 Stk. pc.	> 20 Stk. pcs.	1 Stk. pc.
Silberfarben Silver color	32,50	35,00	39,00	41,00	-	-	-	-
RAL 9010	-	-	-	-	32,50	35,00	39,00	41,00

ANSCHLAGWINKEL DOOR STOPPERS

Art.-Nr.: Art. No.:	09301 	09302 	
	<p>Anschlagwinkel für einflügelige Tür Door stopper for single-leaf door</p>	<p>Anschlagwinkel für zweiflügelige Tür Door stopper for double-leaf door</p>	
€ Stückpreis Price per piece	1 Stk. pc.	1 Stk. pc.	
	31	12,00	23,00
	46	13,00	24,00
	55	15,00	28,00

U-PROFIL & WERKZEUG

U-PROFILE & TOOLS

U-PROFIL U-CHANNEL

Art.-Nr.: Art. No.:	02515	
<p>U-Profil, 15 x 15 x 15 x 2 mm Länge 6000 mm (inkl. zweimal teilen nach Kundenwunsch) Basismaterial: Aluminium</p> <p>U-channel, 15 x 15 x 15 x 2 mm Length 6000 mm (incl. 2 cuts acc. customer request) Base material: aluminum</p>		

€ Stückpreis Price per piece	1 Stk. pc.
31*	131,00
16	41,00
17	98,00

* Oberfläche: Chrom nach DIN 12540. Schnittkanten sind nicht verchromt. Nutzlänge wegen Kontaktstellen ca. 150 mm kürzer.

* Finish: Chrome according to EN 12540. There is no chrome finish on the edges. Usable length is 150 mm shorter because of missing chrome finish on the edges.

WERKZEUGE TOOLS

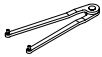
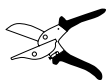
Art.-Nr.: Art. No.:	81499		Art.-Nr.: Art. No.:	99339	
<p>Der Stiftschlüssel ist ein notwendiges Werkzeug für die Montage von Next HS CL und Wellness HS CL</p> <p>The pin spanner is a necessary tool for the installation of Next HS CL and Wellness HS CL</p>		<p>Die Profilschere ist ein notwendiges Werkzeug für den Zuschnitt von Dichtprofilen</p> <p>The seal cutter is a necessary tool for cutting seals</p>			
€ Stückpreis Price per piece	1 Stk. pc.	€ Stückpreis Price per piece		1 Stk. pc.	
	23,00			92,00	

AUSGLEICHSADAPTER

ZUBEHÖR
ACCESSORIES













DISTANCE ADAPTER

Basismaterial: Messing

Base material: Brass

AUSGLEICHSADAPTER DISTANCE ADAPTER



Ausgleichsadapter inkl. Schrauben bei nicht senkrechter / vertikaler Wandfläche für Milano & Milano Pur Glastürbeschläge, G-W 90°
Distance adapter incl. screws for non-vertical walls for Milano & Milano Pur glass door hinges, g-w 90°,



Art.-Nr.: Art. No.:	06050 	06051 	06052 	06053 
	2 mm Ausgleichsadapter inkl. Schrauben 2 mm distance adapter incl. screws	3 mm Ausgleichsadapter inkl. Schrauben 3 mm distance adapter incl. screws	4 mm Ausgleichsadapter inkl. Schrauben 4 mm distance adapter incl. screws	5 mm Ausgleichsadapter inkl. Schrauben 5 mm distance adapter incl. screws
€ Stückpreis Price per piece	1 Stk. pc.	1 Stk. pc.	1 Stk. pc.	1 Stk. pc.
31	30,00	30,00	30,00	30,00
Art.-Nr.: Art. No.:	06054 	06055 	06056 	06057 
	6 mm Ausgleichsadapter inkl. Schrauben 6 mm distance adapter incl. screws	8 mm Ausgleichsadapter inkl. Schrauben 8 mm distance adapter incl. screws	10 mm Ausgleichsadapter inkl. Schrauben 10 mm distance adapter incl. screws	12 mm Ausgleichsadapter inkl. Schrauben 12 mm distance adapter incl. screws
€ Stückpreis Price per piece	1 Stk. pc.	1 Stk. pc.	1 Stk. pc.	1 Stk. pc.
31	30,00	30,00	30,00	30,00
Art.-Nr.: Art. No.:	06058 	06059 	06060 	06061 
	14 mm Ausgleichsadapter inkl. Schrauben 14 mm distance adapter incl. screws	15 mm Ausgleichsadapter inkl. Schrauben 15 mm distance adapter incl. screws	16 mm Ausgleichsadapter inkl. Schrauben 16 mm distance adapter incl. screws	20 mm Ausgleichsadapter inkl. Schrauben 20 mm distance adapter incl. screws
€ Stückpreis Price per piece	1 Stk. pc.	1 Stk. pc.	1 Stk. pc.	1 Stk. pc.
31	30,00	30,00	30,00	30,00

FUNKTIONEN
FEATURES

Selbstschließend, Softclose
Einstellbare Schließgeschwindigkeit
Vollabgedeckte Verschraubung
Als Saunavariante erhältlich
Basismaterial: Messing

Self-closing, Softclose
Adjustable closing speed
Covered backplate, no visible screws
Sauna type hinge available
Base material: Brass

Art.-Nr.: Art. No.:			
09510	09511	09519	
Glastürbeschlag für Innentüren, G-W 90° DIN-rechts, unteres Band Nach außen öffnend Mit zwei Zapfen für Holzzarge Falztiefe 24 mm, Für 8 mm ESG Glass door hinge for interior doors, g-w 90° EN-right, bottom hinge Opens outwards With two joints for wooden frame 24 mm rabbet, For 8 mm tempered glass	Glastürbeschlag für Innentüren, G-W 90° DIN-links, unteres Band Nach außen öffnend Mit zwei Zapfen für Holzzarge Falztiefe 24 mm, Für 8 mm ESG Glass door hinge for interior doors, g-w 90° EN-left, bottom hinge Opens outwards With two joints for wooden frame 24 mm rabbet, For 8 mm tempered glass	Glastürbeschlag für Innentüren, G-W 90° Neutral DIN-rechts/links, oberes Band Nach außen öffnend Mit zwei Zapfen für Holzzarge Falztiefe 24 mm, Für 8 mm ESG Glass door hinge for interior doors, g-w 90° Neutral EN-right/left, upper hinge, Opens outwards With two joints for wooden frame 24 mm rabbet, For 8 mm tempered glass	
€ Stückpreis Price per piece	1 Stk. pc.	1 Stk. pc.	1 Stk. pc.
46	174,00	174,00	174,00
55	186,00	186,00	186,00
65	174,00	174,00	174,00

Art.-Nr.: Art. No.:			
09530	09531	09539	
Glastürbeschlag für Innentüren, G-G 180° DIN-rechts, unteres Band Nach außen öffnend Für 8 mm ESG Glass door hinge for interior doors, g-g 180° EN-right, bottom hinge Opens outwards For 8 mm tempered glass	Glastürbeschlag für Innentüren, G-G 180° DIN-links, unteres Band Nach außen öffnend Für 8 mm ESG Glass door hinge for interior doors, g-g 180° EN-left, bottom hinge Opens outwards For 8 mm tempered glass	Glastürbeschlag für Innentüren, G-G 180° Neutral DIN-rechts/links, oberes Band Nach außen öffnend Für 8 mm ESG Glass door hinge for interior doors, g-g 180° Neutral EN-right/left, upper hinge Opens outwards For 8 mm tempered glass	
€ Stückpreis Price per piece	1 Stk. pc.	1 Stk. pc.	1 Stk. pc.
46	307,00	307,00	307,00
55	324,00	324,00	324,00
65	307,00	307,00	307,00

CHALET PT

PENDELTÜRSYSTEM
DOUBLE ACTION DOOR SYSTEM



FUNKTIONEN
FEATURES



Einstellbare Nulllage (+/- 2,5°)
Selbstschließend
Basismaterial: Messing

Adjustable index position (+/- 2,5°)
Self-closing
Base material: Brass

⁴⁾ Bandblock & Rolle aus Edelstahl (OF 91)

⁴⁾ Hinge block and cylinder made of stainless steel (finish 91)



Art.-Nr.: Art. No.:			
94830	94831	94832	
Glastürbeschlag für Innentüren, G-W 90° Beidseitig öffnend Ohne Feststellung Für 10 mm ESG Glass door hinge for interior doors, g-w 90° Double action Without notch For 10 mm tempered glass	Glastürbeschlag für Innentüren, G-W 90° Beidseitig öffnend Mit Feststellung 90° Für 10 mm ESG Glass door hinge for interior doors, g-w 90° Double action With notch 90° For 10 mm tempered glass	Glastürbeschlag für Innentüren, G-W 90° Beidseitig öffnend Mit Feststellung 85° Für 10 mm ESG Glass door hinge for interior doors, g-w 90° Double action With notch 85° For 10 mm tempered glass	
€ Stückpreis Price per piece	1 Stk. pc.	1 Stk. pc.	1 Stk. pc.
46 ⁴⁾	245,00	245,00	245,00
55 ⁴⁾	233,00	233,00	233,00
65	245,00	245,00	245,00

Art.-Nr.: Art. No.:		
94330	94331	
Glastürbeschlag für Innentüren, G-G 180° Beidseitig öffnend Ohne Feststellung Für 10 mm ESG Glass door hinge for interior doors, g-g 180° Double action Without notch For 10 mm tempered glass	Glastürbeschlag für Innentüren, G-G 180° Beidseitig öffnend Mit Feststellung 90° Für 10 mm ESG Glass door hinge for interior doors, g-g 180° Double action With notch 90° For 10 mm tempered glass	
€ Stückpreis Price per piece	1 Stk. pc.	1 Stk. pc.
46 ⁴⁾	280,00	280,00
55 ⁴⁾	267,00	267,00
65	280,00	280,00

MONTAGEHILFEN

ASSEMBLY AID

BEFESTIGUNGSSCHRAUBEN & MONTAGEHILFEN FIXING SCREWS & ASSEMBLY AID

Art.-Nr. Art. No.:	06750 	06790 	06760 
	Linsenschraube mit Kreuzschlitz 5 x 60 mm Lens head screw with cross recess 5 x 60 mm	Flachkopfschraube mit Kreuzschlitz für Langlochanschraubplatte, 5 x 60 mm Flat headed screw with cross recess for slotted hole screw plate, 5 x 60 mm	Torxschraube mit Flachkopf 5 x 60 mm Torx-screw, flat headed 5 x 60 mm
€ Preis pro Verpackung Price per package	20 Stk. pcs.	20 Stk. pcs.	20 Stk. pcs.
31	40,00	-	-
46	40,00	-	-
65	40,00	-	-
90	40,00	40,00	40,00
91	40,00	40,00	40,00

Die statisch notwendigen Befestigungsmaterialien für die Montage der Duschtürbänder und Winkelverbinder an den tragenden Baukörpern müssen vom Verarbeiter bestimmt werden.
The statically necessary mounting materials for the installation of the shower door hinges and the connectors, onto the load-bearing structure, must be determined by the person responsible for the installation.

MONTAGEHILFE ASSEMBLY AID

Art.-Nr. Art. No.:	06798 	€ Preis pro Verpackung Price per packing unit	10 Stk. pcs.
	Montagehilfe, 6 x 200 x 2 mm Mounting aid, 6 x 200 x 2 mm	Transparenter Kunststoff Transparent synthetic	15,00

ALLGEMEINE GESCHÄFTSBEDINGUNGEN

§ 1 Allgemeines

- Die nachfolgenden Geschäftsbedingungen gelten für die gesamte gegenwärtige und zukünftige Geschäftsbeziehung mit unseren Kunden, auch wenn auf sie nicht ausdrücklich Bezug genommen wird.
- Abweichende oder ergänzende Allgemeine Geschäftsbedingungen des Kunden werden grundsätzlich nicht Vertragsbestandteil.
- Mündliche Nebenabreden haben keine Gültigkeit.

§ 2 Vertragsschluss

- Die Darstellung unseres Sortiments in unseren jeweils aktuellen Katalogen, Prospekten etc. stellt kein bindendes Vertragsangebot dar.
- Mit der Bestellung gibt der Kunde ein verbindliches Angebot ab. An dieses Angebot ist er 6 Wochen gebunden. Das Angebot wird angenommen durch von uns erteilte Auftragsbestätigung oder durch Lieferung der bestellten Waren.

§ 3 Preise

- Die angebotenen Preise verstehen sich in Euro zuzüglich gesetzlicher Mehrwertsteuer.
- Die in Katalogen, Prospekten etc. angegebenen Preise sind freibleibend; Preisänderungen bleiben ausdrücklich vorbehalten.
- Fracht- und Verpackungskosten werden gesondert berechnet.

§ 4 Lieferung

- Angegebene Lieferzeiten sind stets unverbindlich. Sollten wir dennoch in Lieferverzug geraten, hat der Kunde zunächst zur Lieferung eine angemessene Nachfrist zu setzen.
- Bei Abrufaufträgen ohne bestimmte Vereinbarung über den Zeitpunkt des Abrufs, ist der Kunde verpflichtet, die Waren binnen 12 Monaten vollständig abzunehmen; gerechnet ab Bestelldatum der Waren.

§ 5 Transportgefahr

- Erkennt der Kunde bei Erhalt der Lieferung Schäden an der Verpackung, hat er sich bei Annahme der Ware von dem Transportunternehmer die Beschädigung schriftlich bestätigen zu lassen. Transportschäden, die erst nach dem Auspacken der Ware festgestellt werden, müssen innerhalb von fünf Tagen nach deren Erhalt mit Angaben über Beschädigungsart und -grund gemeldet werden.
- Die Gefahr des Untergangs, des Verlustes oder der Verschlechterung der Sache sowie die Preisgefahr gehen mit Auslieferung der Ware an die zur Ausführung der Versendung bestimmte Person auf den Kunden über. Dasselbe gilt für die Gefahr der verzögerten Lieferung. Das gilt auch bei vereinbarter frachtfreier Lieferung der Waren.

§ 6 Zahlung

- Wir liefern:
 - vorbehaltlich der Vereinbarung einer abweichenden Regelung
 - nach Wunsch des Kunden gegen Rechnung oder gegen Nachnahme.
 Es bleibt uns vorbehalten, die Auftragsabwicklung gegen Nachnahme, Teilvorkasse oder totale Vorkasse vorzunehmen. Ggf. erfolgt vorab eine entsprechende Information des Kunden.
- Unsere Rechnungen sind innerhalb von 30 Tagen ab Rechnungslegung ohne Abzug fällig und zahlbar.
- Gerät der Kunde in Zahlungsverzug, ist er verpflichtet, ab Verzugseintritt Zinsen in Höhe von 8 % über dem Basiszinssatz zu zahlen. Wir behalten uns vor, einen höheren Verzugschaden nachzuweisen und geltend zu machen. Der Kunde ist berechtigt, nachzuweisen, dass uns durch den Verzug kein oder ein geringerer Schaden entstanden ist. In jedem Fall besteht Berechtigung zur Verzinsung nach gesetzlichem Zinssatz.
- Ruft der Kunde von uns bereitgestellte Ware nicht ab, ist er verpflichtet, ab Zugang der Versandbereitstellungsanzeige gem. 6.3 Verzugszins zu zahlen.
- Der Kunde kann nur mit solchen Gegenansprüchen aufrechnen, die rechts-

kräftig festgestellt, unbestritten oder von uns anerkannt sind. Ein Zurückbehaltungsrecht kann der Kunde nur aufgrund von Gegenansprüchen geltend machen, die auf demselben Vertragsverhältnis beruhen.

§ 7 Eigentumsvorbehalt

- Die Ware bleibt bis zur vollständigen Bezahlung sämtlicher Forderungen, einschließlich Nebenforderungen, Schadenersatzansprüchen und Einlösungen von Schecks und Wechseln unser Eigentum.
- Der Kunde ist zur Weiterveräußerung, zur Weiterverarbeitung oder zum Einbau der Vorbehaltsware nur unter Berücksichtigung der nachfolgenden Bestimmungen und nur mit der Maßgabe berechtigt, dass die Forderungen gemäß der nachfolgenden Ziffer auf den Käufer auch tatsächlich übergehen.
- Der Kunde tritt hiermit alle etwaigen Forderungen aus dem Weiterverkauf der Vorbehaltsware an uns ab.
- Die Befugnis des Kunden, im ordnungsgemäßen Geschäftsverkehr Vorbehaltsware zu veräußern, zu verarbeiten oder einzubauen endet mit dem Widerruf durch uns, insbesondere bei nachhaltiger Verschlechterung der Vermögenslage des Kunden, spätestens jedoch mit seiner Zahlungseinstellung oder mit der Beauftragung bzw. Eröffnung des Insolvenz- oder Vergleichsverfahrens über sein Vermögen.
- Der Kunde ist ermächtigt, so lange er seinen Zahlungsverpflichtungen nachkommt, die abgetretenen Forderungen einzuziehen. Die Einziehungsermächtigung erlischt bei Widerruf, spätestens aber bei Zahlungsverzug des Kunden bzw. bei wesentlicher Verschlechterung seiner Vermögensverhältnisse. In diesem Fall sind wir berechtigt und vom Kunden bevollmächtigt, die Abnehmer von der Abtretung zu unterrichten und die Forderung selbst einzuziehen.
- Der Kunde ist verpflichtet, uns auf Verlangen eine genaue Aufstellung der ihm zustehenden Forderungen mit Namen und Anschriften der Abnehmer, Höhe der einzelnen Forderungen, Rechnungsdaten etc. auszuhandigen und uns alle für die Geltendmachung der abgetretenen Forderungen notwendigen Auskünfte zu erteilen und die Überprüfung dieser Auskünfte zu gestatten.
- Die o. g. Abtretung des Kunden wird durch uns angenommen.

§ 8 Werkzeuge und Schutzrechte

- Werkzeuge und Vorrichtungen bleiben in unserem Eigentum; dies gilt auch, wenn der Kunde die Herstellungskosten übernimmt.
- Die Vorhaltung der Werkzeuge und Vorrichtungen erfolgt mind. 12 Monate nach zuletzt erfolgter Lieferung.
- Bei Herstellung von Produkten nach Zeichnungen, Modellen und Mustern des Kunden, gewährleistet dieser, dass keine Schutzrechte Dritter verletzt werden. Er stellt uns unter Gewährung einer angemessenen Vorschusszahlung für Rechtsverfolgungskosten von Ansprüchen Dritter frei.

§ 9 Toleranzen / Maß- und Gewichtsangaben / Qualitätsanforderungen

- Wir behalten uns vor, Produktveränderungen, die aus unserer Sicht einer Qualitätsverbesserung dienen, auch ohne Vorankündigung durchzuführen.
- Angaben über Maße, Gewichte, Eigenschaften, Traglasten, Fassungsvermögen, Beständigkeitsangaben usw. sind betriebs- und branchenübliche Annäherungswerte. Konstruktionsänderungen und unerhebliche Abweichungen von der Qualität und Ausführung der Produkte, die durch Materialien oder technische Gründe bedingt sind, bleiben vorbehalten.
- Technische Angaben und Qualitätsanforderungen gelten gemäß unserem technischen Katalog in seiner jeweils letzten gültigen Fassung.

§ 10 Warenrückgabe

- Die Rückgabe von Ware an uns ist nur nach folgenden Kriterien möglich:
- Rücknahme nur nach vorheriger Absprache und schriftlicher Zusage unsererseits
 - Die Rücksendung erfolgt auf Rechnung des Kunden

- Nur unbeschädigte Ware in Originalverpackung (keine Beschläge, die schon montiert waren)
- Keine Sonderanfertigungen oder Sonderfarben
- Keine Glaselemente
- Ware nicht älter als 4 Wochen nach Lieferung
- Für zurückgegebene Waren wird eine Wiedereinlagerungsgebühr fällig
- Wiedereinlagerungsgebühr 10% des Warenwertes, mindestens 35,00 € netto pro Sendung.

§ 11 Gewährleistung

1. Wir leisten für Mängel der Ware nach unserer Wahl Gewähr durch Nachbesserung oder Ersatzlieferung.
2. Schlägt die Nachbesserung oder Ersatzlieferung fehl, kann der Kunde nach seiner Wahl Herabsetzung der Vergütung oder Rückgängigmachung des Vertrages verlangen.
3. Die Waren sind unverzüglich nach Ablieferung auf ihre Mängelfreiheit und Vollständigkeit zu überprüfen und dabei entdeckte Mängel uns unverzüglich anzuzeigen. Versäumt der Kunde die rechtzeitige Untersuchung oder Mängelanzeige, so gilt die gelieferte Ware als genehmigt, es sei denn, der Mangel war bei der Untersuchung nicht erkennbar.
4. Die Gewährleistungs- und Schadenersatzansprüche richten sich nach den geltenden gesetzlichen Vorschriften.

§ 12 CE Kennzeichnung und gesetzliche Bestimmungen zur Nutzung unserer Produkte

1. **Diverse Normvorschriften auch im Rahmen der CE Kennzeichnung gelten für Gesamtprodukte, in der Regel aus Glas, für die unsere Beschläge nur einen Teil darstellen.**
2. **Wir versichern die Eignung unserer Produkte dann und nur dann, wenn sie gemäß Normen und unseren Vorgaben zur Herstellung des gesamten Elements verbaut werden. Es dürfen ausschließlich nur Teile aus unserem Haus oder von uns zugelassene Zubehörteile verwendet werden.**
3. **Der Kunde versichert, dass er unsere Produkte nur von zugelassenem Fachpersonal unter Berücksichtigung unserer technischen Angaben montieren lässt und übernimmt die Haftung dafür. Bei Nichtbeachtung erlischt unsererseits jegliche Gewährleistung.**

§ 13 Technische Richtlinien, QS Standards und Gewährleistungsstandards **Es gelten die Angaben unseres Technikkatalogs auch zu den Beurteilungen der Oberflächen, des Materials, des Einbaus etc. Dies ist Bestandteil des Liefervertrages.**

§ 14 Schlussbestimmungen

1. Es gilt das materielle Recht der Bundesrepublik Deutschland.
Das UN-Übereinkommen über Verträge über den internationalen Warenkauf findet keine Anwendung.
2. Ist der Kunde Kaufmann, juristische Person des öffentlichen Rechts oder öffentlich-rechtliches Sondervermögen, ist ausschließlicher Gerichtsstand für alle Streitigkeiten aus diesem Vertrag das Landgericht Bonn.
Dasselbe gilt, wenn der Kunde keinen allgemeinen Gerichtsstand in Deutschland hat.
3. Sollten einzelne Bestimmungen des Vertrages zwischen uns und dem Kunden einschließlich dieser Allgemeinen Geschäftsbedingungen ganz oder teilweise unwirksam sein oder werden, oder sollte sich hierin eine Lücke befinden, so wird hierdurch die Gültigkeit der übrigen Bestimmungen nicht berührt.
4. Es wird darauf hingewiesen, dass die Kundendaten getrennt als Bestands- und als Abrechnungsdaten im Rahmen der gültigen datenschutzrechtlichen Regelungen gespeichert werden.

KL megla Germany GmbH, Waldbröl, Deutschland

GENERAL TERMS AND CONDITIONS

§ 1 General statements

For all sales and deliveries only the following conditions are valid. In case of different possibilities of interpretation due to translations the original German version is valid. Differing agreements, especially conditions of purchasing, are only effective, if we confirm them in writing. Silence does not mean acceptance. In case the customer is an entrepreneur, the following conditions are also valid for future business transactions between him and us, even when they are not agreed on again explicitly.

§ 2 Prices

The prices of our quotes and acceptances of order are subject to confirmation. We charge the prices valuable at the time of delivery. Freight and packing see page 6.6, valid only within Germany. Unless agreed upon differently all export prices are ex works. If the delivery is within Germany all prices are subject to German VAT. Within the European Union we need the VAT identification number. The custom laws have to be considered.

§ 3 Orders

We will confirm the acceptance of orders in writing. Orders are only valid by our written confirmation – in exceptional cases also by immediate delivery and issuing an invoice. Changes, supplementary agreements and amendments of the contract have to be agreed on in written form in order to be valid. In case that no definite delivery date is agreed on with release orders, a maximum delivery time of twelve months is in effect. If the merchandise is not received within that time, we are entitled – after an adequate time – to arrange the delivery scheduling (delivery will take place after payment), or to cancel the rest of the purchase and to demand damages for non-performance.

§ 4 Transportation risk and delivery

All deliveries are at the risk of the customer. The risk passes over to the customer from the (outgoing) place of delivery. This is valid even if free delivery is agreed on. If the delivery is delayed by fault of the customer the risk passes over to the customer on the day the merchandise is ready for delivery. Insurance against transport damage will only be arranged for if the customer explicitly demands it and at his expense. Shipping instructions have to be given with the placement of the order, otherwise the merchandise will be shipped at our own discretion for the cheapest freight, without obligation.

§ 5 Tools, appliances

Tools and appliances always remain in our possession and property, even if they were produced for special articles. By payment of portions of costs for tools and appliances the customer does not acquire a title. We commit ourselves to keep tools and appliances for the customer twelve months after the last delivery. If the customer states before the expiration of this time limit that further orders will be placed, the time limit will be extended for another twelve months. After the expiration of this time limit limit we can freely dispose of the tools and appliances.

§ 6 Catalogues, drawings and samples

We reserve the right of property and the copy rights of all provided catalogues, drawings and samples. These documents may not be used for copying, imitation, or circulation. For your own use we are glad to send you more copies at cost.

§ 7 Delivery and acts of nature

Quoted times of delivery are always without obligation. We always try to complete an order promptly and in time. The time of delivery starts with the day of the sending of the confirmation of order and is deemed to be kept, if the merchandise has left our factory by the end of the delivery period. Acts of nature which happen after conclusion of a contract and complicate our services or make them impossible, entitle us to defer the fulfilment of our obligations for the time of the interference and an adequate start-up time. Acts of nature include especially strikes, lockouts, breakdown of transportation, lack of production material or energy or similar occurrences which we are not accountable for. If acts of nature lead

to a final, lasting, irreparable hindrance of performance we are entitled to withdraw from the contract.

§ 8 Warranty

Any warranty presumes that any customer who is an entrepreneur has met his legal obligations of reprehension without hesitation. Any customer who is not an entrepreneur, forfeits his rights of warranty regarding to apparent damages if he does not claim them in written form within fourteen days after receiving the merchandise. Defects of one part can not lead to reclamation of the whole delivery.

For delivered goods which are insufficient we either deliver a replacement with return of the reclaimed parts or remove the deficiency at our choice. If the replacement or the remedy fails, the customer can demand a reduction of the purchasing price or a cancellation of the contract at his choice. We can demand a compensation if we acted upon a notice of defects and the customer has not proved the existence of a defect or the claimed defect proves to be a malfunction or failure because of a repair or an act of the customer or a third person.

In case we fulfill the warranty obligation at another place than the place of delivery the charges for freight, packing and travelling have to be covered by the customer, if he is an entrepreneur.

§ 9 Liability

We are liable with initial incapacity, accountable impossibility, warranties, default and for claims of product liability.

For claims out of positive violation of demands we are not liable in case of breach of non significant contract duties, if we or one of our auxiliary persons acted only slightly negligent. Essential duties of the contract are duties of which the observance is indispensable for the realization of the contract.

Damage payments are limited to the replacement of the typical foreseeable damage. Collateral damage is not refundable, unless the replacement for collateral damages was explicitly assured. Any liability for damages exceeding the ones provided for in these conditions of contract is excluded without consideration of the legal basis of the asserted claim. This is not effective for claims according to § 1,4 of the German product liability law and out of fault liability during the closing of the contract. With claims out of producer liability according to § 823 BGB (German law) our liability – unless it is excluded is limited to the replacement of the insurance. In case the insurance does not stand up for the liability or only does so in part, we are liable up to the limit of the indemnity.

§ 10 Default of the customer

If the customer is in delay with the takeover of the goods, he owes damages amounting to 0,5% of the bill for every commenced month from the beginning of the notification of the readiness for shipment, unless he proves that no damage occurred to us or the damage is lower. Our demands which exceed the quoted rate remain unaffected.

§ 11 Returns

The return of delivered goods can only be accepted meeting the following criteria:

- Return only with prior consultation and our written consent
- Merchandise which is to be returned always has to be send free of charge
- Only undamaged Merchandise in original packing (no previous mounted fittings)
- No custom made products and finishes
- No Glass panels
- No merchandise, which are older than 4 weeks after delivery
- For returned Merchandise a re-stocking fee will be charged
- Charges for re-stocking are 10% of the goods value, minimum 35,00 Euro net for each shipment

§ 12 Terms of payment

Only the terms of payment which are agreed upon at the time of the contract of sale and are stated in our confirmation of order. If not agreed

upon otherwise we only accept prepayment or letters of credit. If the payment period is exceeded we are entitled to charge an interest rate 5% higher than the basic interest rate according to the §1 of the Discount rate transition law of 06-09-1998 (German law). All claims are due right away after default of payment, cheque or bill protests and also if circumstances are disclosed that can lead to the conclusion that the financial situation of the customer is deteriorating or that the creditworthiness does not seem to be given anymore. We accept cheques and drafts only as auxiliary means, drafts only after prior agreement. Draft collection charges and eventual further costs have to be covered by the customer.

In case a draft is used for payment we can not accept cash discounts. With the payment of our bill we do not accept external costs and bank charges.

§ 13 Retention of title

The delivery of all items of purchase remains under retention of title in our favor until the complete and final payment of all claims existing from the time of the conclusion of the contract; if the customer is an entrepreneur also the future claims which will result out of the business relationship. This is also valid if single claims are added to outstanding accounts and the balance is struck and recognized. If the conduct of the customer is substantially contrary to the contract, especially by delay of payment, we are entitled to take back the merchandise. Taking back the merchandise does not mean cancellation of the contract, unless we explicitly declared that in written form.

Garnishment of the merchandise through us always means a cancellation of the contract. After taking back the merchandise we are entitled to the disposal. The proceeds of a sale is to be credited to the account of the customer, in the sequence cost, interest, main claim.

The claim of the customer out of the resale of the items of retention is assigned to us already now in the height of the value of the items of retention to secure the claims named in the previous passage. If the customer has agreed on an open account with his customer, the causal and recognized account balance out of this open account relationship is assigned to us even now.

The customer is entitled and authorized to further processing, to resale and secondary purchase of the items of retention within proper business dealings provided that the claim out of the resale is vested to us in the quoted sense. The customer is not entitled to other dispositions of the items of retention, especially pledging or chattel mortgage.

The customer is entitled to the collection of claims out of the resale in spite of the assignment. Our collection authority will remain unaffected by the collection authority of the customer. We will not collect the debts ourselves, however, as long as the customer is not in delay with his payment. On request the customer has to name us the debtor of the assigned debts and inform the debtor about the assignment.

We commit ourselves to release the above stated securities due to us in so far as their nominal value exceeds the claims that have to be secured by 15 %, provided, however, that with the exception of a delivery on a real open item basis a release can only take place for such deliveries or their replacement value which are themselves paid completely.

The customer has to inform us immediately in writing about any intervention of a third party concerning our property rights, including the address of the third party. All judicial and extra judicial costs resulting by successful interventions have to be covered by the customer, as soon as the collection of the debts from the respective debtor was unsuccessful.

If the matter of purchase is acquired by a third party, we are entitled to demand the release by ourselves, without the involvement of the customer. The customer bears the duties, risks, liabilities, taxes, duties and other burdens which are connected with ownership, possession, the purchase and the operation of the item of purchase. He is liable for deliberately and negligently caused damages as well as for culpable or coincidental loss or damage of the item of purchase. Every damage of the item of purchase or its eventual loss has to be reported to us immediately. If our merchandise is machined or processed, or connected or mixed with other parts by the customer we become co-owner of the new item in proportion of the item of retention to the other parts. The customer will keep the new item for us. In case the customer sells himself under retention of title, this is considered as agreed on in trust for the goods/ items of our ownership or joint ownership.

In case of insolvency proceedings we have the right of the exemption of

our goods according to the insolvency regulation.

§ 14 Prohibition of assignment

Claims of the customer against us can not be transferred to a third party without our consent.

§ 15 Rights of retention and summation

The claim of rights of refusal of performance and retention is excluded if the customer is an entrepreneur, unless the contrary right is legally established or beyond controversy. In all cases summation is only acceptable in uncontested or legally established claims.

§ 16 Trade mark rights

In case items have to be produced according to drawings, models or samples of the customer, the customer assumes the warranty, that by the production and delivery no trade mark rights of a third party are violated. He exempts us from all claims of such a third party. For eventual costs of litigation in case of such a claim we have a claim against the customer of a reasonable payment in advance.

§ 17 CE marking and legal provisions for the use of our products

1. Various standard regulations, for example within the framework of the European CE marking guidelines, apply to complete modules, for example glass shower doors, of which our components are only a part
2. We insure the suitability of our products if and only if they are installed in accordance with standards and our specifications for the manufacture of the entire element. Exclusively our parts or accessories approved by us may be used.
3. The customer assures that he will have our products installed by authorized specialists taking our technical information into account. Failure to comply will void any warranty and liability on our side.

§ 18 Technical guidelines, QA standards and warranty standards

The information in our technology catalog also applies to assessments of surfaces, materials, installation, etc. This is part of the delivery contract.

§ 19 Inseverability clause

If any one or more section, subsection, sentence, clause, phrase, word, provision or application of this Ordinance shall for any person or circumstance be held to be illegal, invalid, unenforceable, and/or unconstitutional, such decision shall not affect the validity of any other section, subsection, sentence, clause, phrase, word, provision or application of this Ordinance which is operable without the offending section, subsection, sentence, clause, phrase, word, provision or application shall remain effective notwithstanding such illegal, invalid, unenforceable, and/or unconstitutional section, subsection, sentence, clause, phrase, word, provision or application, and every section, subsection, sentence, clause, phrase, word, provision or application of this Ordinance are declared severable. The legislature hereby declares that it would have passed each part, and each provision, section, subsection, sentence, clause, phrase or word thereof, irrespective of the fact that any one or more section, subsection, sentence, clause, phrase, word, provision or application be declared illegal, invalid, unenforceable, and/or unconstitutional.

§ 20 Place of execution, court of jurisdiction, applicable law

For all deliveries and contractual activities of both contractual partners the place of execution is Bonn, Germany.

The United Nations Convention on Contracts for the International Sale of Goods, CISG is not applicable.

For all litigations only the local court in Bonn, Germany or the district court in Cologne, Germany has jurisdiction, if the customer is an entrepreneur, unless no other court of jurisdiction is prescribed by German law. We can, however, also appeal to the court having jurisdiction at the location where the customer is located or registered.

In any case only German law is applicable under exclusion of the agreement of the United Nations about contracts concerning the international purchase of goods.

KL meglä Germany GmbH, Waldbroel, Germany

MINDESTAUFTRAGSWERT

MINIMUM ORDER VALUE

Mindestauftragswert 100 € netto/Auftrag

Minimum order value: 100 € net/order

VERSANDKOSTEN

SHIPPING COSTS

Handlings, Verpackungs- und Frachtkosten

Lieferung innerhalb Deutschlands

Für Bestellungen im Wert von 1.000,00€ netto: Lieferung kostenfrei

Für Bestellungen unter 1.000,00€ netto: 10,00€ Handlings- und Verpackungspauschale zuzüglich UPS Kosten, siehe Tabelle:

UPS Standard Paket / pro Paket	< 30 Kg
Türbänder, Winkel Beschläge	15,00€ netto
Stabilisationsstangen	15,00€ netto
Dichtprofile, U-Profile, Laufschiene < 2500 mm	25,00€ netto

Zusatzkosten für Samstagszustellung oder Lieferung an eine Privatadresse: 27,50€ netto

Wichtige Hinweise

- Die Art der Verpackung bleibt uns vorbehalten.
- Die Fracht- und Verpackungskosten berechnen sich je Verpackungseinheit.
- Langgut > 2500 mm – 6000 mm werden ausschließlich nur per Spedition versendet. Preise auf Anfrage.
- Bei eintreffender Ware muss diese auf Schäden untersucht werden. Sollte ein Schaden oder eine Fehlmenge festgestellt werden, muss die Meldung innerhalb von 5 Arbeitstagen erfolgen. Bei Direktversand an Ihren Kunden bleibt das in Ihrer Verantwortung. Spätere Schadensmeldungen können nicht mehr akzeptiert werden. Bitte setzen Sie sich in solchen Fällen umgehend mit uns in Verbindung.
- Die Anlieferung erfolgt ebenerdig.
- Saisonalbedingte Preisanpassungen (z.B. im Weihnachtsgeschäft) sowie treibstoffabhängige Zuschläge vorbehalten.
- Bitte beachten Sie, dass sämtliche Logistiker nicht nur zum Jahreswechsel bei Bedarf Preisanpassungen vornehmen. Daraus resultierende notwendige Preisanpassungen behalten wir uns ausdrücklich vor.

Lieferung ins europäische Ausland und nach Übersee

Für Lieferungen ins Ausland stellen wir Ihnen gerne individuelle Preise für das jeweilige Land zur Verfügung.

Individuelle Vereinbarungen

Wir bieten eine Vielzahl von individuellen Vereinbarungen an, u.a.:

- Ab einem Jahresumsatz von 50.000 € netto kostenfrei wöchentliche Sammlieferungen
- Abholung durch einen Dienstleister des Kunden
- Direktversand im Auftrag des Kunden
- Rahmenaufträge mit Sondervereinbarung
- Expressversand oder Botenlieferung
- Individuelle Verpackung
- Individuelles Labeling

Handling, Packing and Freight cost

Deliveries within Germany

For orders with a net value above 1.000,00€: free shipment

For orders with a net value below 1.000,00€: 10,00€ net handlings- and packing fee plus UPS charge, see table:

UPS standard package / per package	< 30 kgs
Hinges, connectors, fittings	15,00€ net
Stabilization bars	15,00€ net
Seals, U-profiles, carrier bars < 2500 mm	25,00€ net

Surcharge for delivery on Saturday or to a private address: 27,50€ netto

Important notes

- We reserve the right to choose the type of packaging.
- The freight and packaging costs apply per packaging unit.
- Long goods > 2500 mm – 6000 mm are only sent by traditional shipping companies. Prices on request.
- When goods arrive, they must be examined for damage. If damage or a shortage is found, the report must be made within maximum 5 working days. In the case of direct shipping to your customer, this remains your responsibility. Later notifications of damage can not be accepted. Please contact us immediately in such cases.
- Delivery is at ground level.
- We reserve the right to make seasonal price adjustments (e.g. during Christmas business) and fuel-dependent surcharges.
- Please note that all freight companies do not only make price adjustments at the turn of the year if necessary. We expressly reserve the right to make any necessary price adjustments accordingly.

Deliveries to European Countries and Overseas

For deliveries in other countries, we can provide individual freight costs, for each country.

Individual agreements

We offer a variety of individual agreements, including:

- From an annual turnover of 50,000€ net on, free weekly collective deliveries
- Collection by a service provider of the customer
- Direct delivery on behalf of the customer
- Framework orders with special arrangement
- Express delivery or delivery by courier
- Individual packing
- Individual labeling

OBERFLÄCHEN & SONDEROBERFLÄCHEN

Als Manufaktur sind wir Ihr direkter Ansprechpartner für den zunehmenden Trend zur Anpassung der Beschlagoberfläche an z.B. Sanitär-farben verschiedener Hersteller.

Da wir hauptsächlich mit Messing arbeiten, nutzen wir zudem ein ideales Grundmaterial für sehr viele Oberflächen.

Diverse Verfahren sind möglich: Galvanische, PVD- (nach Verchromung), und Pulver-Beschichtung sowie Lackierung.

Eloxal-Oberflächen sind nur bei Aluminium möglich, die Optik kann aber bei Messing durch Galvanische Prozesse sehr gut angenähert werden, z.B. Mattchrom statt EV1.

Für bestimmte mechanisch beanspruchte Teile sind nicht alle Oberflächen geeignet. Besonders Lackierung oder Pulverbeschichtung halten den Druck oder den Abrieb nicht aus. Teils sind die betreffenden Teile auch aus Edelstahl gefertigt – da ist PVD die einzig sinnvolle Beschichtung.

Hinweise:

- A) Abhängig vom Produkt kann aus beschriebenen Gründen bei mechanisch beanspruchten Teilen eine Art „Bicolor“ erforderlich sein, z.B. eine Chromschicht oder PVD.
- B) Bei Edelstahlteilen in polierter Oberfläche sind materialbedingte stecknadelgroße Einschlüsse möglich.
- C) Zur Beurteilung der Oberfläche gelten die Richtlinien in unserem Technikkatalog, auf Wunsch als Download verfügbar.

Alle Beschläge mit Sonderoberflächen sind grundsätzlich Sonderanfertigungen. Sie werden von uns nicht bevorratet. Das gilt auch für nicht beschichtete Teile. Eventuelle Zusatz- oder Ersatzteile sollten mitbestellt werden. Spätere Nachfertigungen sind oftmals unverhältnismäßig aufwendig und bedingen ggf. Farbabweichungen.

Preise für Sonderoberflächen sind nicht hinterlegt, müssen jedes Mal auftrags- bzw. objektbezogen neu kalkuliert werden und gelten maximal für 6 Wochen oder nach Absprache. Der Hintergrund ist, dass wir die Preisgestaltung für Sie optimieren. Die Kosten können je nach Stückzahl, Gesamtvolumen und Fertigungszeitraum und Verfahren sehr stark schwanken. Wir erarbeiten gerne ein Angebot.

Wichtig: Für Kunden, die selbst Teile beschichten können, können wir auch polierte Gehäuseteile als Sonderanfertigung herstellen, an den Beschichter liefern und nach Rücksendung montieren. Das lohnt sich in den meisten Fällen allerdings weder von den Kosten noch von der Lieferzeit und führt zum Ausschluss der Gewährleistung. Nicht montierte Beschläge liefern wir schon aus Haftungsgründen grundsätzlich nicht.

Da Sonderoberflächen ohnehin eine Sonderanfertigung bedeuten, kann im Verfahren teils gleichzeitig auch eine Modifikation der Form erfolgen, z.B. eine angeschliffene Facette.

Ebenfalls möglich: Lasergravur, z.B. mit Ihrem Logo oder dem Ihres Kunden.

FINISHES & SPECIAL FINISHES

As a manufacturer, we are your direct contact for the increasing trend towards adapting the hardware finish to e.g. sanitary colors from different manufacturers.

Since we mainly work with brass, we also use an ideal base material for a large number of finishes.

Various processes are possible: plating, PVD (after chrome plating) and powder coating as well as painting.

Anodized finishes are only possible with aluminum, but the look can be approximated very well with brass by plating processes, e.g. matt chrome instead of silver anodized.

Not all finishes are suitable for certain mechanically stressed parts. Painting or powder coating in particular cannot withstand the pressure or abrasion. Some of the parts in question are also made of stainless steel – PVD is the only useful coating in this case.

Notes:

- A) Depending on the product, a kind of “bicolor” may be required for mechanically stressed parts for the reasons described, e.g. a chrome layer or PVD.
- B) In the case of stainless steel parts with a polished finish, inclusions the size of a pin are possible.
- C) To assess the finish, the guidelines in our technology catalog apply, available as a download on request.

All fittings with special finishes are basically custom-made. We do not stock the products. This also applies to uncoated parts. Any additional or spare parts should be ordered right away. Subsequent reproductions are often disproportionately expensive and may result in color deviations.

Prices for special finishes are not saved, must be recalculated every time for the specific order or project and are valid for a maximum of 6 weeks or by arrangement. The background is that we optimize the pricing for you. The costs can fluctuate very greatly depending on the number of pieces, the total volume and the production period and process. We would be happy to prepare an offer.

Important: For customers who can coat parts themselves, we can also manufacture polished housing parts as custom-made products, deliver them to the plater and assemble them after they are returned to us. In most cases, however, this is not economic in terms of costs or delivery time and leads to the exclusion of the warranty. For reasons of liability, we generally do not deliver unmounted fittings.

Since special finishes require a custom-made product anyway, the process can sometimes also be used to modify the shape, e.g. a beveled facet.



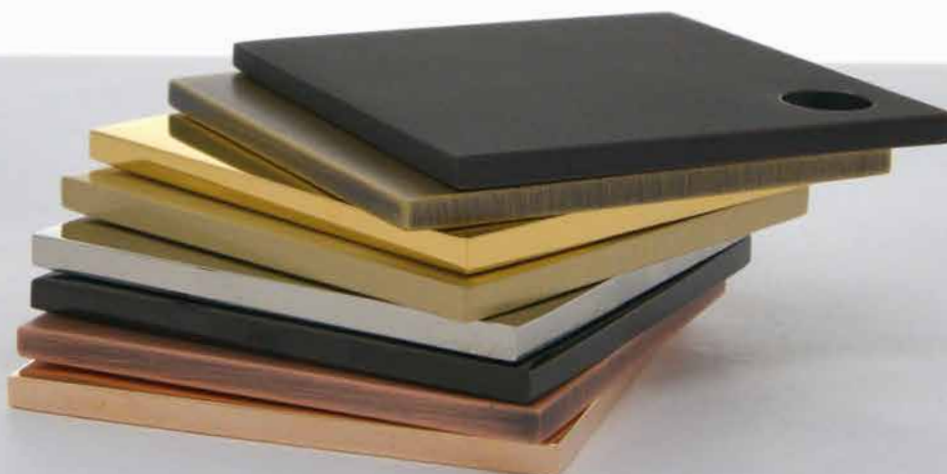











Possible upon request: laser engraving, e.g. with your or your customer's logo.



OBERFLÄCHEN FINISHES

SONDEROBERFLÄCHEN-BEISPIELE SPECIAL FINISHES - EXAMPLES

Oberfläche Finish	Kennziffer für Artikelnummer Article No. endings for finish	
ALUMINIUMBASIS: ALUMINUM BASE:		
Silberfarbig eloxiert Silver color anodized	10	
Chromähnlich eloxiert (ähnlich OF 31 bei Galvanik) Chrome color anodized (like finish 31 with plating)	11	
Gebeizt, silberfarbig eloxiert (EV1 ähnlich OF 46 bei Galvanik) Stained, silver-colored anodized (like finish 46 with plating)	16	
Alinox (Edelstahleffekt, ähnlich OF 55 bei Galvanik) Alinox (stainless steel effect, like finish 55 with plating)	17	
MESSINGBASIS: BRASS BASE:		
Glanzverchromt Bright chrome	31	
Mattverchromt Satin chrome	46	
Nickel gebürstet (Edelstahloptik) Brushed nickel (stainless steel look)	55	
ONYX schwarz ONYX black	65	
EDELSTAHLBASIS: STAINLESS STEEL BASE:		
Edelstahl poliert Polished stainless steel	90	
Edelstahl gebürstet Brushed stainless steel	91	

Sonderoberfläche Special Finishes	Kennziffer für Artikelnummer Article No. endings for finish	
Glanzvernickelt Bright nickel	36	
Mattvernickelt Satin nickel	51	
Nickel gebürstet (Edelstahloptik) Brushed nickel (stainless steel look)	55	
Messing Braun Brass brown	59	
Feingold Fine gold	61	
Gelbgold (Farbton ähnlich wie Messing) Yellow gold (brass color)	62	
Altkupfer gebürstet mit Klarlack Brushed old copper with clear varnish	63	
Altbronze gebürstet mit Klarlack Brushed old bronze with clear varnish	64	
Matt vergoldet Satin gold plated	67	
Vergoldet mit Roségold Rosé gold plated	68	
Messing gebürstet mit Klarlack Brushed brass with clear varnish	69	
RAL 9005 schwarz matt pulverbeschichtet RAL 9005 matt black powder coated	81	
RAL 9010 weiß matt pulverbeschichtet RAL 9010 white matt powder coated	82	
RAL 9005 schwarz glänzend pulverbeschichtet RAL 9005 glossy black powder coated	84	

MUSTERPLATTEN FINISH SAMPLE PLATE

Oberflächen Musterplatte Finish Sample Plate

1 Stück
1 piece



10101

Musterplatten, 60 x 60 x 4 mm, sind in verschiedenen Oberflächen erhältlich.
Sample plates, 60 x 60 x 4 mm, are available in different finishes.

Preis auf Anfrage
Price on request

